

TC-K71

US Model
 Canadian Model
 AEP Model
 UK Model
 E Model



'Dolby' and the double-D symbol are the trade marks of Dolby Laboratories. Noise reduction system manufactured under license from Dolby Laboratories.

STEREO CASSETTE DECK

SPECIFICATIONS

GENERAL

Power Requirements: AEP model:
 220 V ac ~, 50/60 Hz
 (240 V ac ~ adjustable by authorized Sony personnel)
 UK model:
 240 V ac ~, 50/60 Hz
 (220 V ac ~ adjustable by authorized Sony personnel)
 US, Canadian model:
 120 V ac, 60 Hz
 E model:
 110, 120, 220 or 240 V ac, 50/60 Hz

Power Consumption: 28 W (AEP, UK, E model)
 26 W (US, Canadian model)

Dimensions: Approx. 430(w) x 130(h) x 290(d) mm
 17(w) x 5¹/₈(h) x 11¹/₂(d) inches (AEP, UK, US, E model)
 Approx. 460(w) x 130(h) x 290(d) mm
 18(w) x 5¹/₈(h) x 11¹/₂(d) inches (Canadian model)
 including projecting parts and controls

Weight: Approx. 5.6 kg, 12 lb 6 oz (AEP, UK, US, E model)
 Approx. 6.3 kg, 13 lb 15 oz (Canadian model)

SAFETY-RELATED COMPONENT WARNING!

COMPONENTS IDENTIFIED BY SHADING AND MARK  ON THE SCHEMATIC DIAGRAMS, EXPLODED VIEWS AND IN THE PARTS LIST ARE CRITICAL TO SAFE OPERATION. REPLACE THESE COMPONENTS WITH SONY PARTS WHOSE PART NUMBERS APPEAR AS SHOWN IN THIS MANUAL OR IN SUPPLEMENTS PUBLISHED BY SONY.

ATTENTION AU COMPOSANT AYANT RAPPORT À LA SÉCURITÉ!

LES COMPOSANTS IDENTIFIÉS PAR UNE TRAME ET UNE MARQUE  SUR LES DIAGRAMMES SCHEMATIQUES, LES VUES EXPLOSEES ET LA LISTE DES PIÈCES SONT CRITIQUES POUR LA SÉCURITÉ DE FONCTIONNEMENT. NE REMPLACER CES COMPOSANTS QUE PAR DES PIÈCES SONY DONT LES NUMÉROS SONT DONNÉS DANS CE MANUEL OU DANS LES SUPPLÉMENTS PUBLIÉS PAR SONY.

— Continued on page 2 —

Tape Transport Mechanism Type

TCM-100V11

SONY
SERVICE MANUAL

TAPE RECORDER SECTION

Recording System: 4-track 2-channel stereo

Fast-forward and Rewind Time: Approx. 80 sec. (with C-60)

Frequency Response: DOLBY NR OFF
AEP, UK, E model

- With TYPE IV cassette (Sony METALLIC)
 - 20 – 20,000 Hz
 - 30 – 18,000 Hz (± 3 dB)
 - 30 – 13,000 Hz (± 3 dB, 0 VU recording)
 - 30 – 18,000 Hz (DIN)
- With TYPE III cassette (Sony Fe-Cr)
 - 20 – 20,000 Hz
 - 30 – 18,000 Hz (± 3 dB)
 - 30 – 18,000 Hz (DIN)
- With TYPE II cassette (Sony CD- α)
 - 20 – 19,000 Hz
 - 30 – 17,000 Hz (± 3 dB)
 - 30 – 17,000 Hz (DIN)
- With TYPE I cassette (Sony BHF)
 - 20 – 17,000 Hz
 - 30 – 15,000 Hz (DIN)

US, Canadian model

- With TYPE IV cassette (Sony METALLIC)
 - 20 – 20,000 Hz
 - 30 – 18,000 Hz (± 3 dB)
 - 30 – 13,000 Hz (± 3 dB, 0 VU recording)
- With TYPE III cassette (Sony Fe-Cr)
 - 20 – 20,000 Hz
 - 30 – 18,000 Hz (± 3 dB)
- With TYPE II cassette (Sony EHF)
 - 20 – 19,000 Hz
 - 30 – 17,000 Hz (± 3 dB)
- With TYPE I cassette (Sony HFX)
 - 20 – 17,000 Hz

Wow and Flutter: 0.04 % WRMS (NAB) } (AEP, UK, E model)
 ± 0.12 % (DIN)
 0.04 % WRMS (US, Canadian model)

S/N Ratio: DOLBY NR OFF
AEP, UK, E model

- With TYPE IV cassette (Sony METALLIC)
 - 60 dB at peak level (NAB)
 - 60 dB (DIN)
- With TYPE III cassette (Sony Fe-Cr)
 - 60 dB at peak level (NAB)
 - 60 dB (DIN)
- With TYPE II cassette (Sony CD- α)
 - 58 dB at peak level (NAB)

US, Canadian model

- With TYPE IV cassette (Sony METALLIC)
 - 60 dB at peak level
- With TYPE III cassette (Sony Fe-Cr)
 - 60 dB at peak level
- With TYPE II cassette (Sony EHF)
 - 58 dB at peak level

DOLBY NR ON
Improved by 5 dB at 1 kHz, 10 dB above 5 kHz

Total Harmonic Distortion: 0.8 % (with Sony Fe-Cr and METALLIC)

Bias Frequency: 105 kHz

Inputs: MIC (phone jacks) 2
 sensitivity 0.25 mV (-70 dB)
 for a low-impedance microphone

LINE IN (phono jacks) 2
 sensitivity 77.5 mV (-20 dB)
 input impedance 50 k Ω

Outputs: LINE OUT (phono jacks) 2
 output level 0.435 V (-5 dB)
 at load impedance 50 k Ω
 with LINE OUT level control at "0" variable
 in five steps from -5 dB to -29 dB load
 impedance more than 10 k Ω

PHONES (binaural jack) 1
 output level variable in five steps from
 -20 dB to -44 dB at load impedance of 8 Ω

LED PEAK PROGRAM METERS

Response Range: -40 dB to $+8$ dB

Frequency Response: 20 – 20,000 Hz ± 1.5 dB

Response Time: 1 millisecond

Decay Time
(from 0 dB to -20 dB): 750 milliseconds

Overshoot: None

Indicator Elements: 16 elements for each channel

0 dB = 0.775 V

SERVICING NOTE

When the top cover is removed, the internal photo transistor may pick up stray light and shut the set off.

MODEL IDENTIFICATION

— Specification Label —

SONY®	TAPECORDER
	MODEL NO TC-K71
	SERIAL NO _____
MADE IN JAPAN	

- US, Canadian model: AC 120 V 60 Hz 26 W
- AEP model: AC 220 V ~ 50/60 Hz 28 W
- UK model: AC 240 V ~ 50/60 Hz 28 W
- E model: AC 110, 120, 220, 240 V ~ 50/60 Hz 28 W

Handling Precautions for MOS ICs

Generally, the insulation resistance of the oxide layer in MOS IC structures is very high, and the oxide layer is very thin. Because of this, it is possible that the static voltages usually present on clothes and the human body will be enough to generate a potential difference across the insulator, high enough to cause a breakdown of the insulating layer.

The following precautions should be taken while handling these ICs.

(Particular care should be taken under conditions of low humidity.)

Precautions in Replacing MOS ICs

1. Store new ICs by inserting them into a urethane-polyester cushion (which is somewhat conductive), or wrapping it in aluminum foil, so that all the pins are at the same potential. (The ICs should be stored in that manner until mounted on the circuit board.)

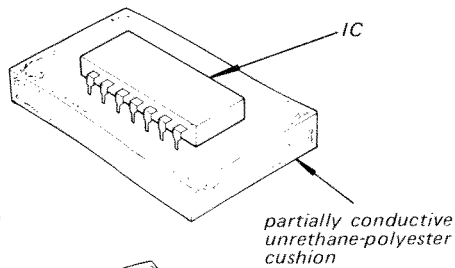

Fig. A

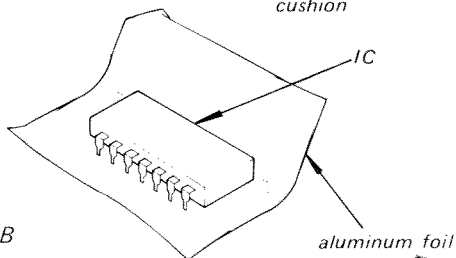

Fig. B

2. Check the soldering iron for possible power-line leakage current. Make sure that there is no leakage path by connecting an ohmmeter to the tip of the soldering iron and the plug as shown in Fig. C. If there is a leakage path, use some other soldering iron.

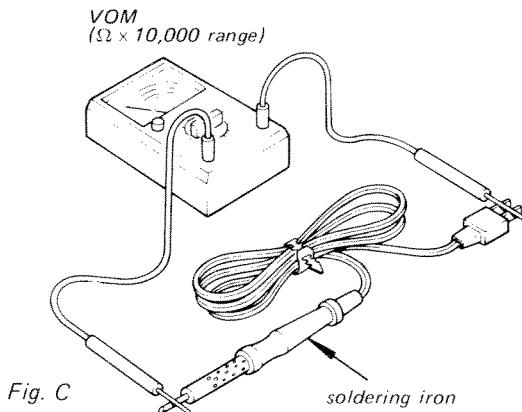

Fig. C

3. Equalize any potential difference between the clothes, the tools in use, the work bench, the set being worked on, and the packaged IC by touching them all in succession with the hands or a conductive wire or tool.
4. The following are effective methods for handling ICs that remove the potential difference across the oxide layer.
 - Use a paper clip modified by soldering in a wire braid insert.

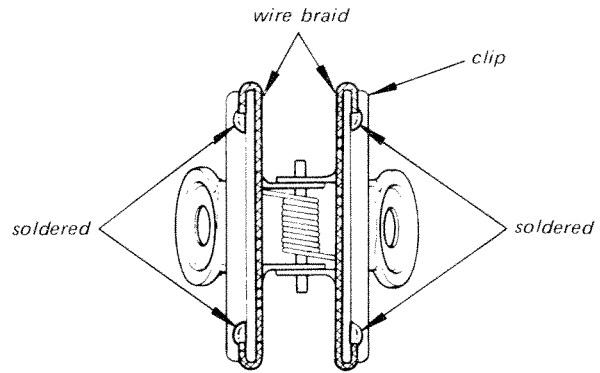

Fig. D

Make sure that there is no solder on the inside.

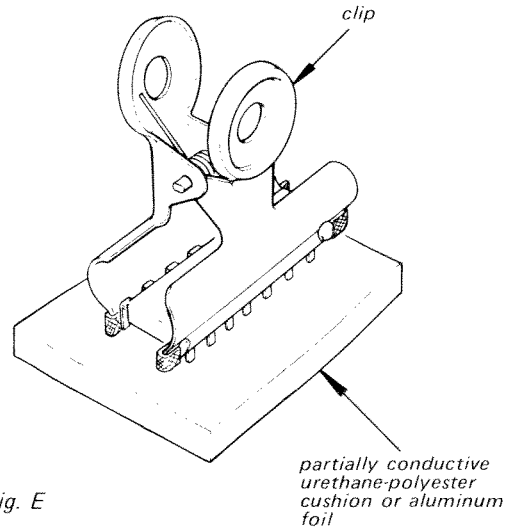
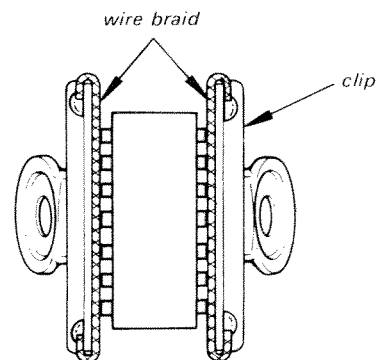

Fig. E



Make sure that all the pins are in contact with the wire braid (all the pins will then be at the same potential.).

Fig. F

- Take a short length of fine bare wire and wind it around the IC so that it shorts all the pins of the IC, while it is still in the urethane-polyester cushion or aluminum foil. This ensures that all the pins are at the same potential.

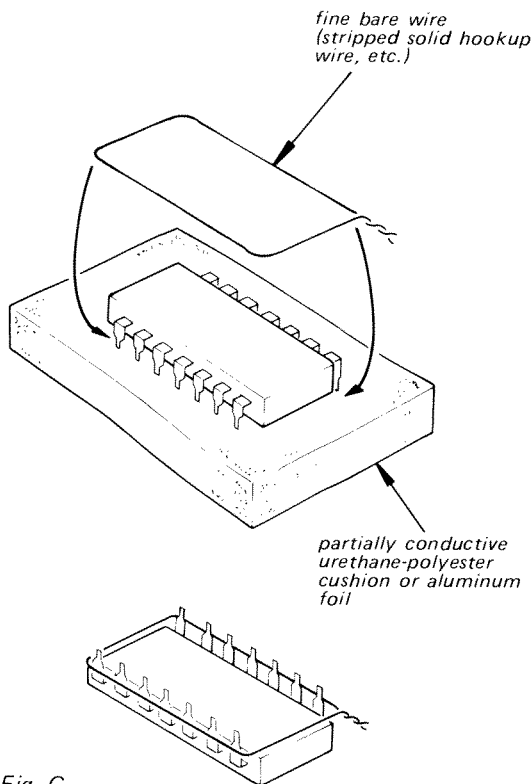

Fig. G

- When it is necessary to handle the IC with the fingers, do not touch any pin, and hold the IC at the ends of its plastic-package case as shown in Fig. H.

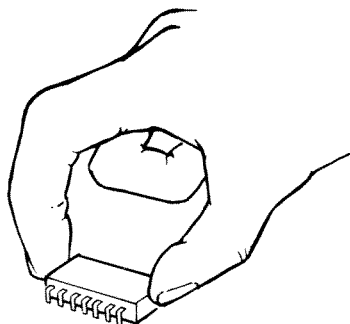

Fig. H

5. Method of Mounting

Insert the IC while holding it with the modified clip, and solder all the pins with the clip still shorting the pins. (Similarly, solder all the pins while the bare shorting wire is still wound around them.). Remove the clip or the bare shorting wire only after all the pins have been soldered.

Precaution while Checking C-MOS ICs

The C-MOS ICs (Complementary MOS) are MOS ICs that have their output sections made up of N-channel and P-channel push-pull stages to increase their speed of operation. If the output terminal of these ICs comes into contact with B+ or B- voltage, then the FET which is ON at that time will either become shorted or open.

This is valid for all the output sections that are connected together by the interconnections. Even the circuits that are physically separated (and not on the same board) can be destroyed simultaneously.

Example:

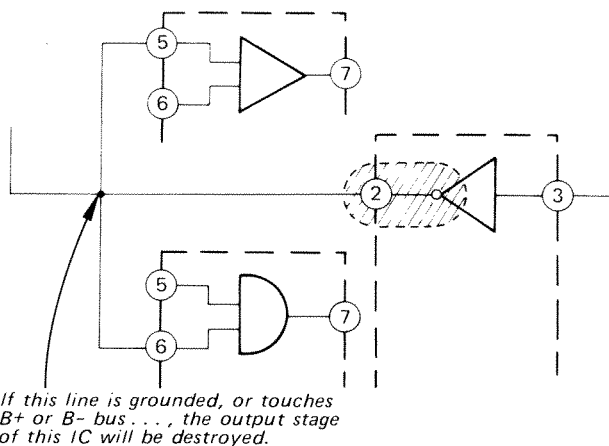

Fig. I

SECTION 1
OUTLINE

1-1. CIRCUIT OPERATION

This set is equipped with an LED peak program meter, which indicates the input signal level (as a bar graph).

The following explanations describe the operation of each of the circuit.

1. IC601 Input Circuit

Input signal **A** (waveform **A**) is amplified by Q107 and is applied to IC103 in the LOG converter circuit. By the characteristic of a diode, the input signal is logarithmically compressed and waveform **A** changes into waveform **B**.

The peak of signal **B** is detected by D105 and smoothed by C130, Then it is applied to terminal **(11)** of IC601 as dc voltage (waveform **C**). Q109 controls the input current which is applied to IC601.

2. LED Indication Circuit

The LEDs turn on when the anode signals (**D** - **G**) and the cathode signals (**H** - **O**) drop to a LOW level at the same time.

ex) LINE OUT output -5dB

D, **F** : LOW level

↓
waveform **H** - **O** : anode, cathode: LOW level

↓
L-CH/R-CH : LEDs 1~8 turn on
(See Diagram 1.)

LED MATRIX DIAGRAM

anode signal \ cathode signal	L-CH		R-CH	
	D	E	F	G
H	1	9	1	9
I	2	10	2	10
J	3	11	3	11
K	4	12	4	12
L	5	13	5	13
M	6	14	6	14
N	7	15	7	15
O	8	16	8	16

Diagram 1.

(When either two of the signals **D** - **G**) and of **H** - **O** drop to LOW level, the LEDs shown in the diagram turn on.)

3. Peak Hold Reset Circuit

1) Mode: S7 **AUTO**

The trigger pulse generated by Q601 (PUT=Programmable Unijunction Transistor) is applied to the base of Q602. The reset signal is applied to the reset terminal **(12)** of IC601 at intervals of 2.25 seconds and the peak level is reset.

2) Mode: S7 **MANUAL**

When the MANUAL switch is turned on, B+ voltage is applied to the base of Q602. Then reset terminal **(12)** of IC601 drops to a LOW level and the peak level is reset.

Measuring Condition
 LINE IN: 1 kHz, 0.25V (-10 dB)
 LINE OUT: 0.44V (-5 dB)
 Mode: record/forward
 MONITOR SWITCH: SOURCE

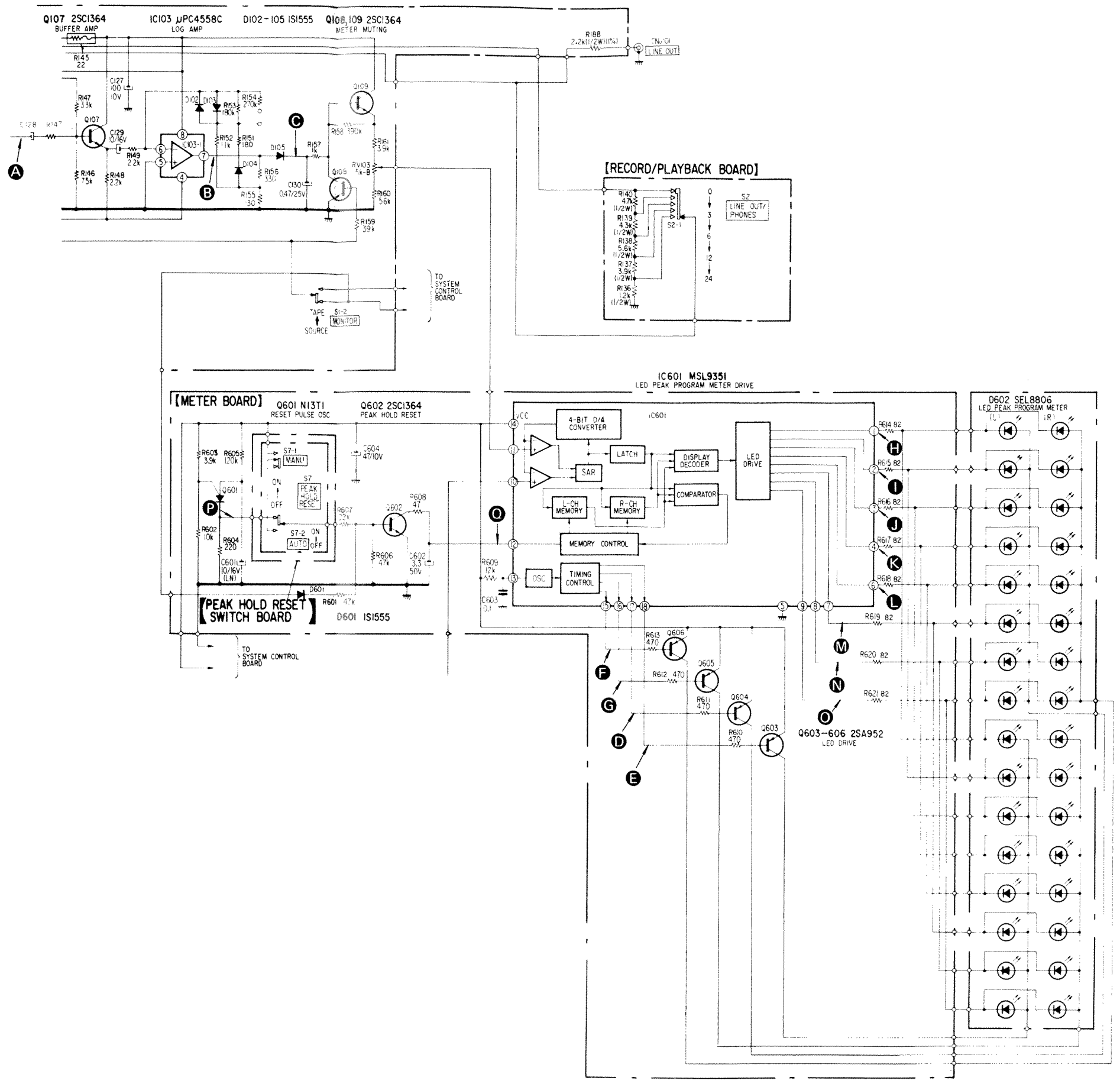
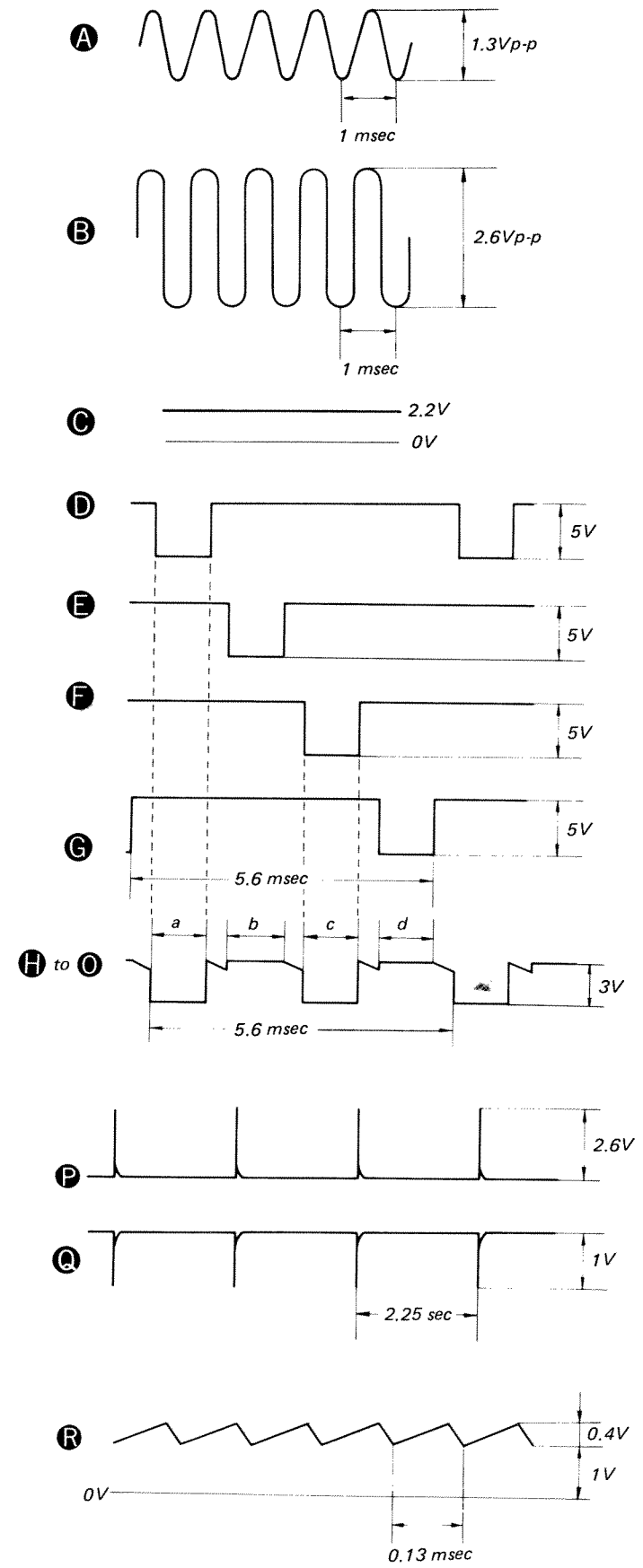

1-2. BLOCK DIAGRAM

— System Control Section —

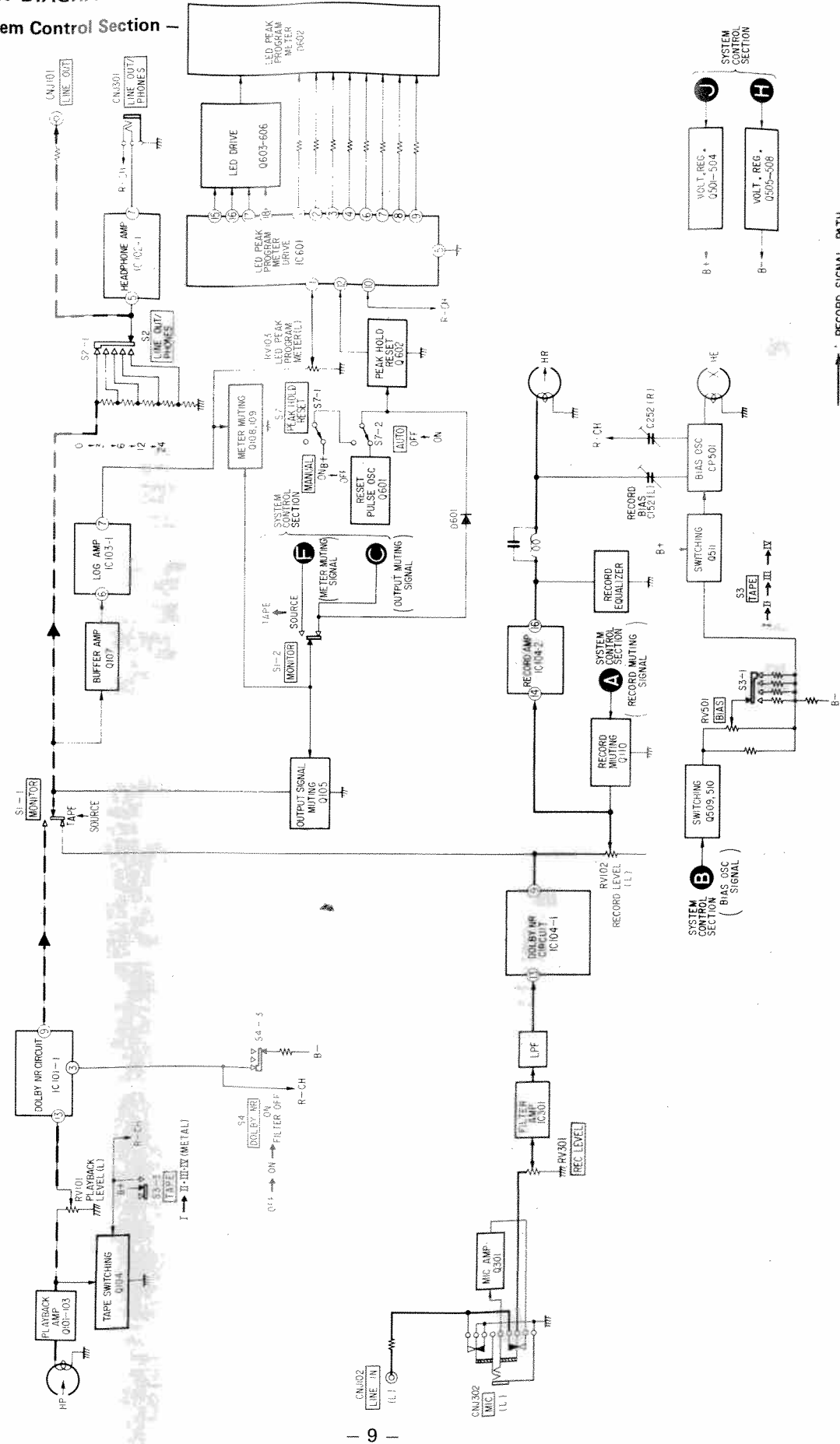

— R-CH —
SAME AS L-CH

— RECORD SIGNAL PATH —
— PLAYBACK SIGNAL PATH —

TC-K71 TC-K71

— Audio Amp Section —

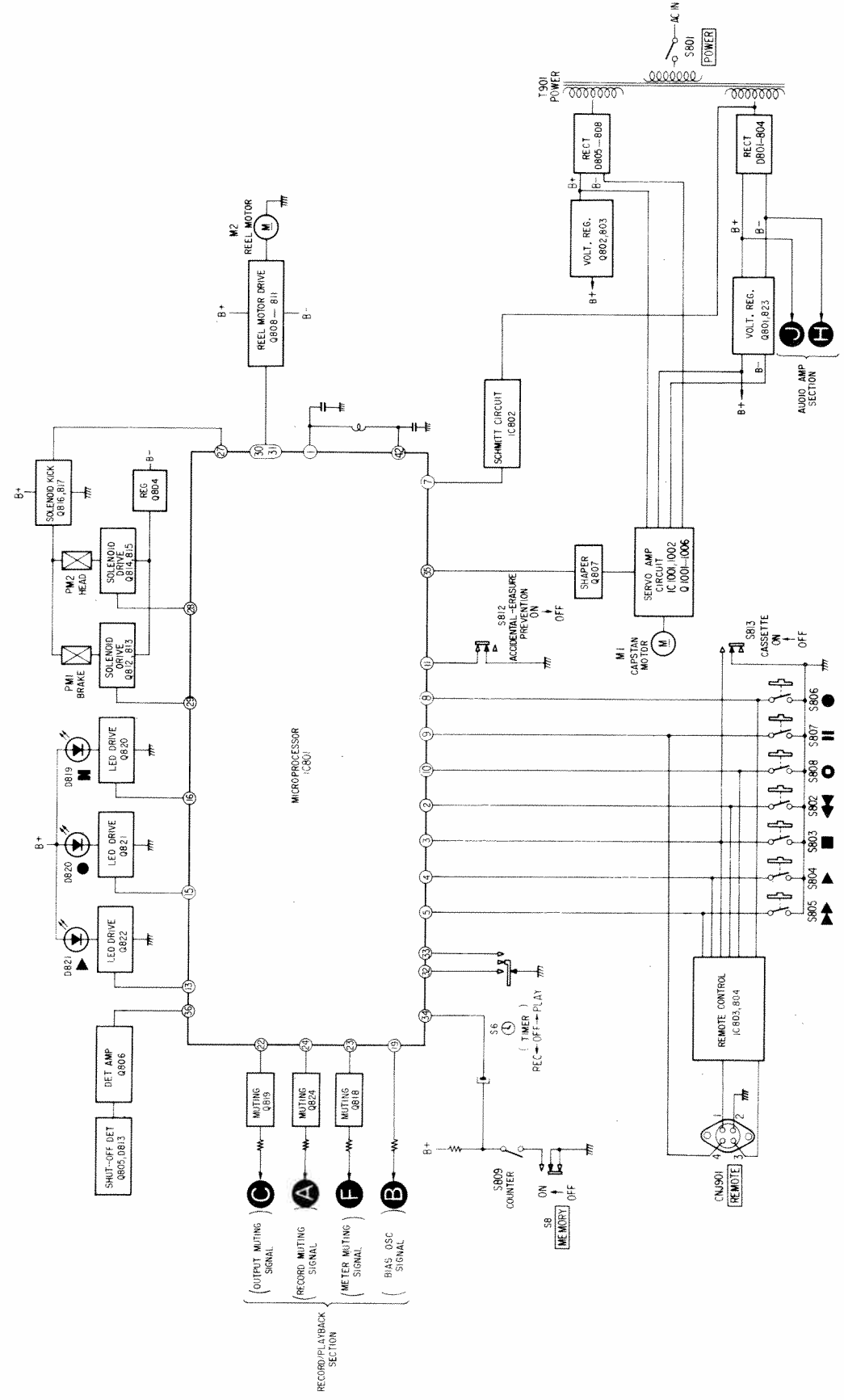

SECTION 2 DISASSEMBLY

Note: Follow the disassembly procedure in the numerical order given.

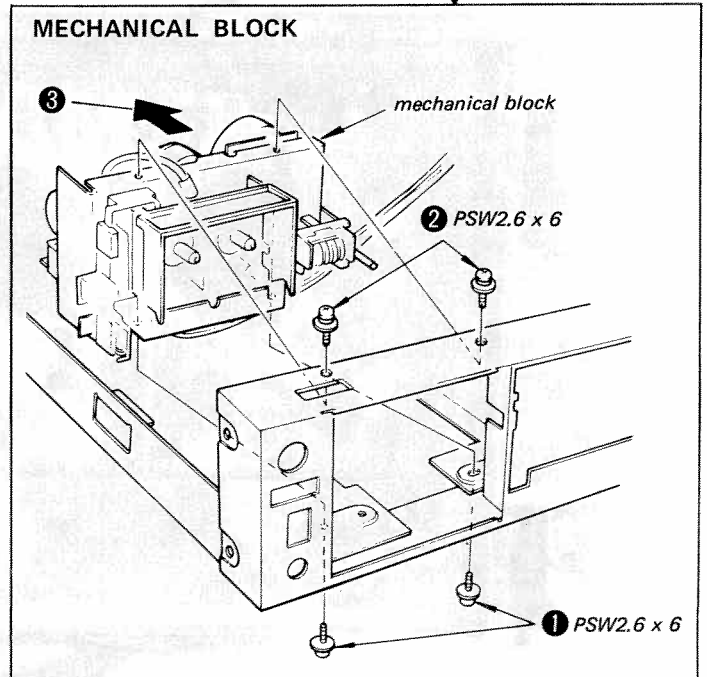
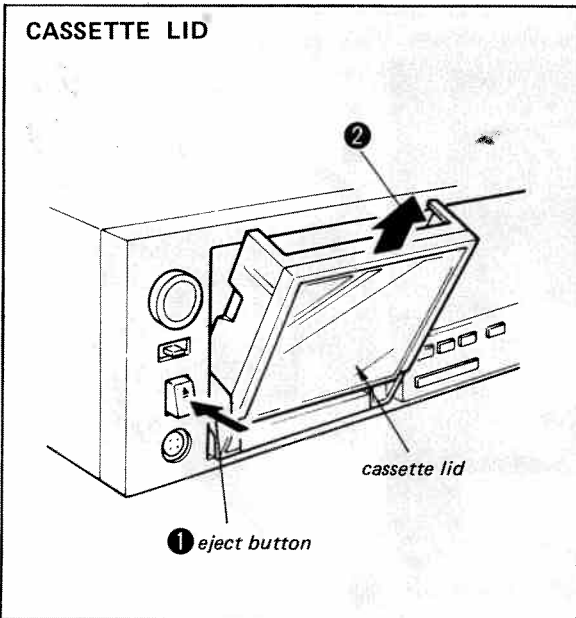
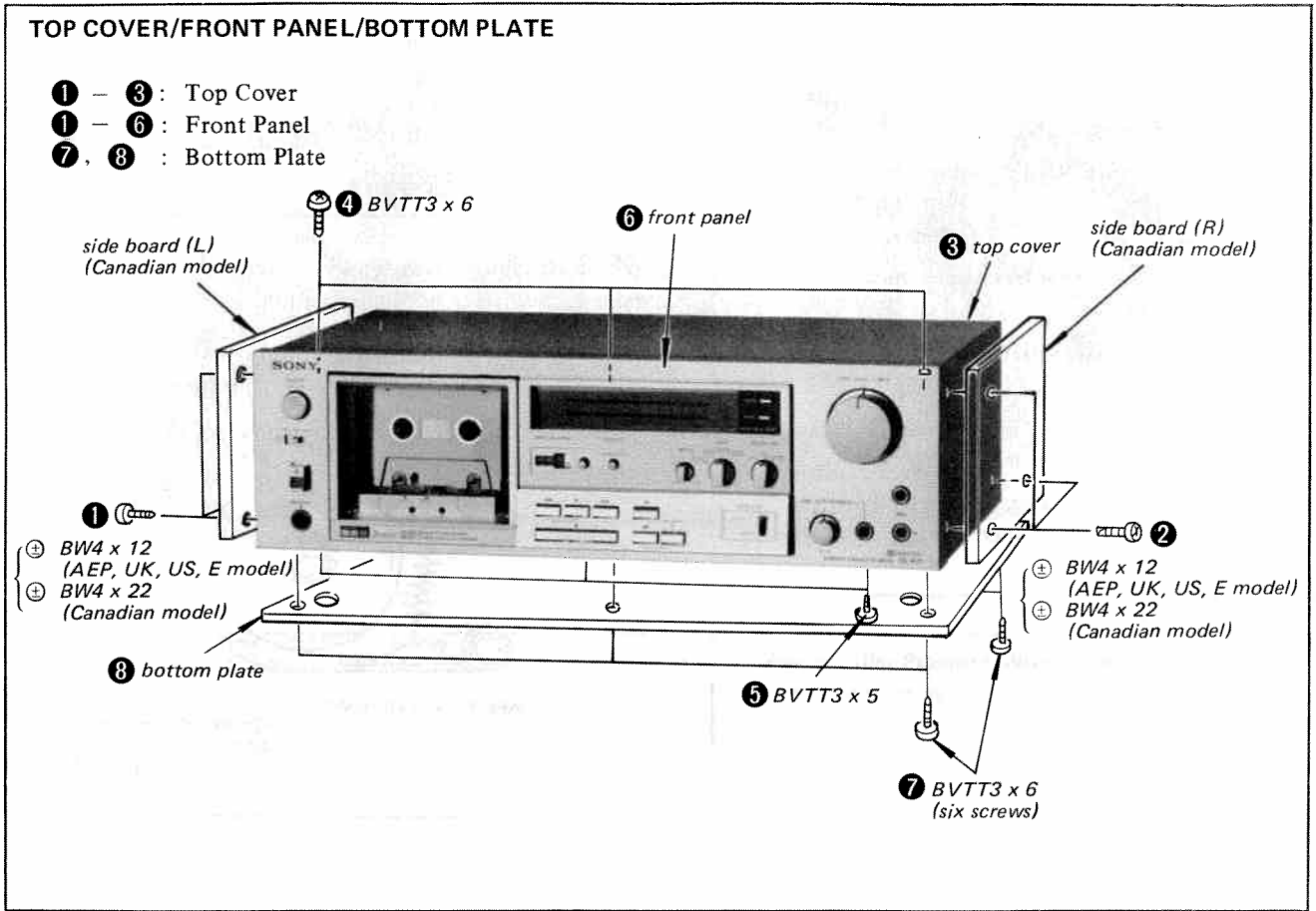

SECTION 3 ADJUSTMENTS

3-1. MECHANICAL ADJUSTMENTS

PRECAUTION

1. Clean the following parts with a denatured-alcohol-moistened swab:

record/playback head	pinch rollers
erase head	rubber belts
capstans	idlers
2. Demagnetize the record/playback head with a head demagnetizer.
3. Do not use a magnetized screwdriver for the adjustments.
4. After the adjustments, apply suitable locking compound to the parts adjusted.
5. The adjustments should be performed with the rated power supply voltage unless otherwise noted.

Torque Measurement and Back Tension Torque Adjustment

1.	Torque	Torque meter	Meter reading
	Forward	CQ-102C	28-50 g·cm (0.39-0.69 oz·inch)
	Back tension	CQ-102C	9-11 g·cm (0.13-0.15 oz·inch)
	Fast Forward, Rewind	CQ-201B	80-140 g·cm (1.12-1.94 oz·inch)

2. If the specified back-tension torque is not obtained, change the hooking position.

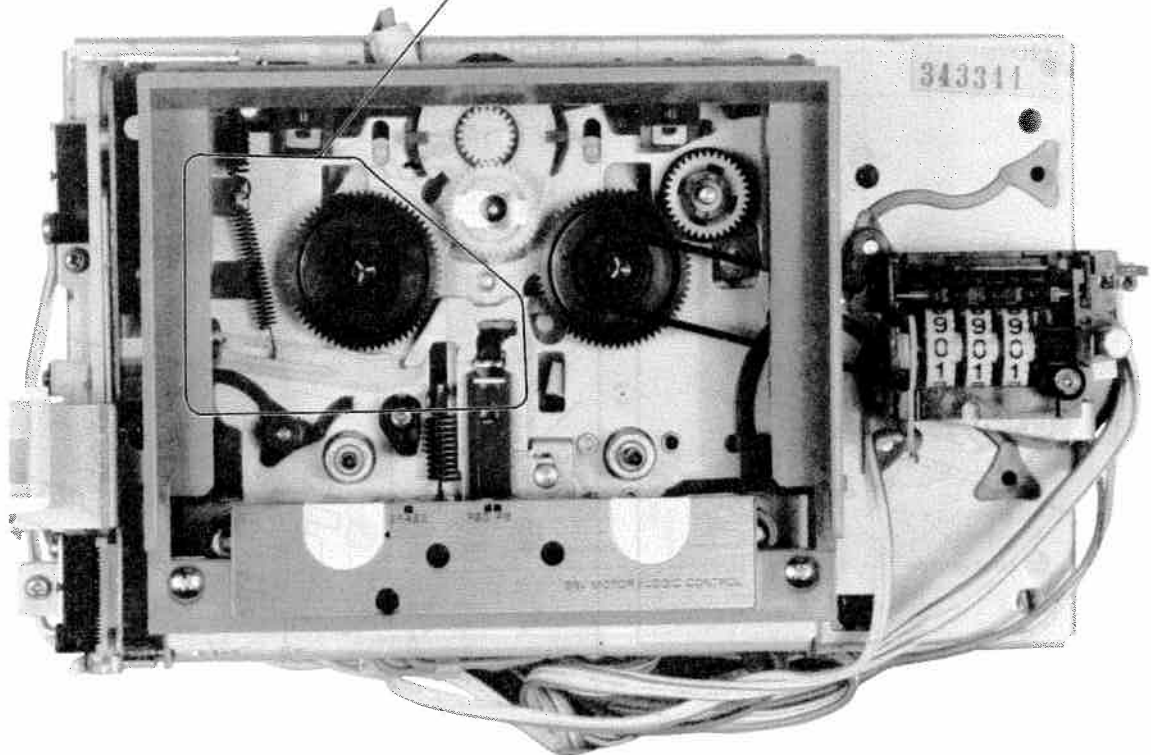
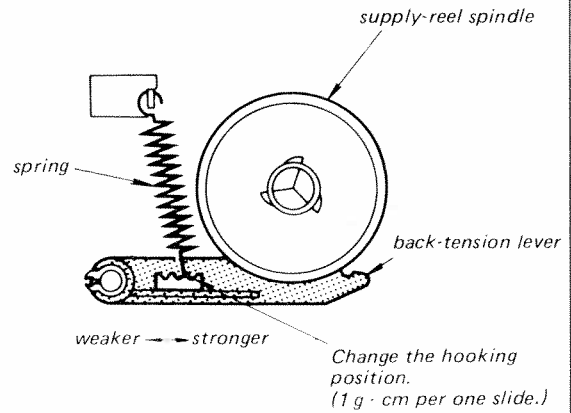

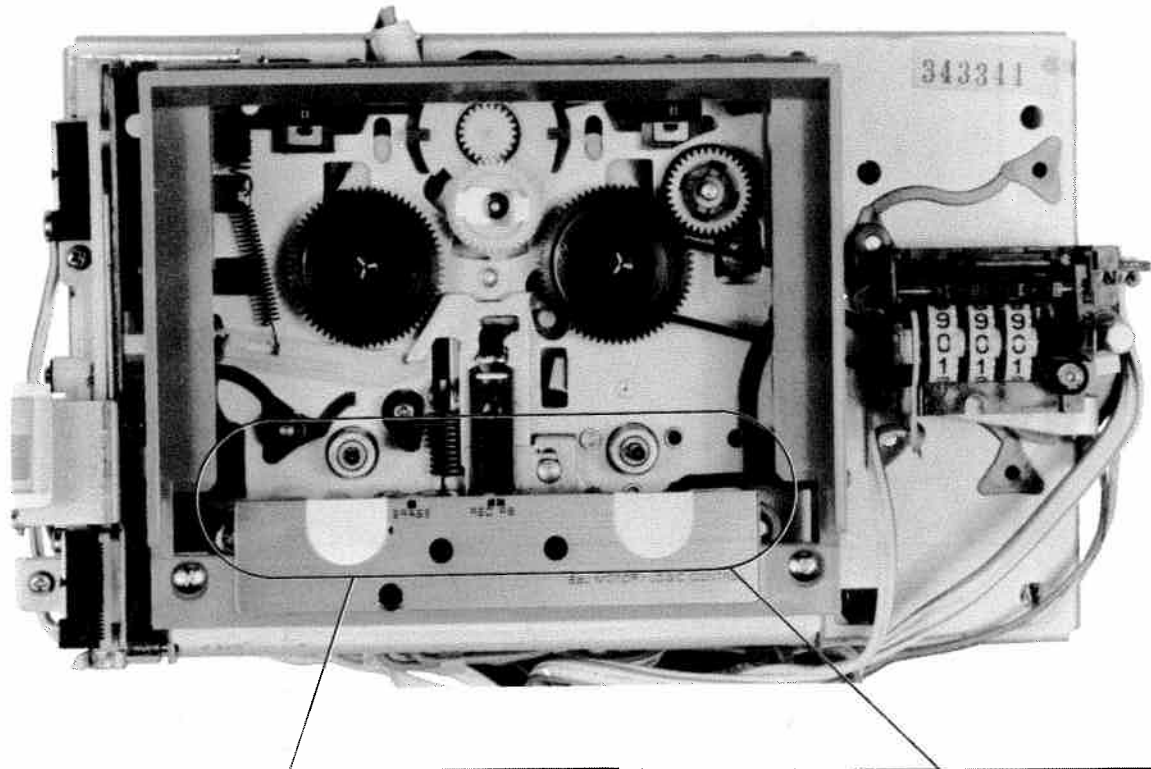

Head Height Adjustment

1. Prepare an adjustment cassette as shown below.

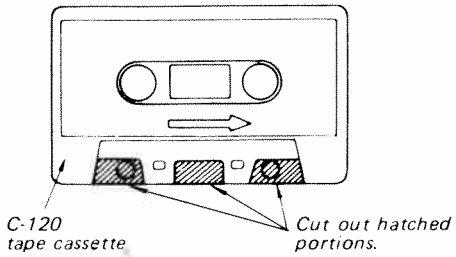

2. In playback mode and viewing from the front, adjust the head heights to eliminate tape curl and tape twist at portions shown by arrows.

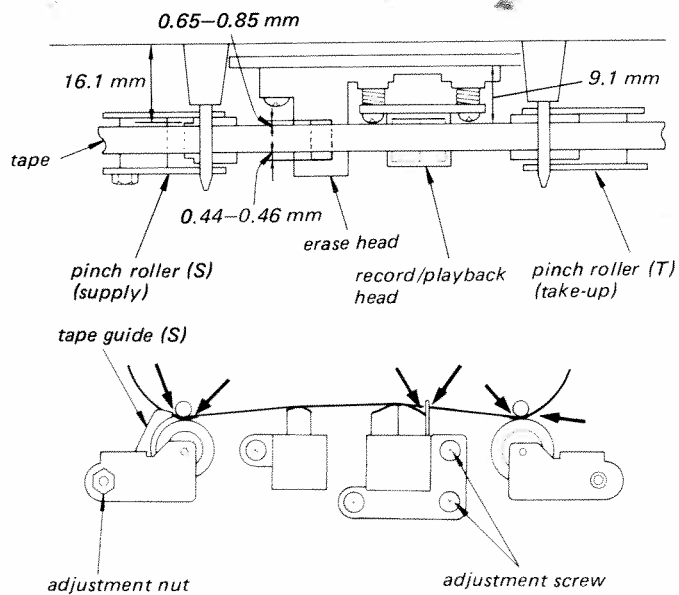

Pinch Roller Pressure Measurement

– Forward Mode –

1. Confirmation

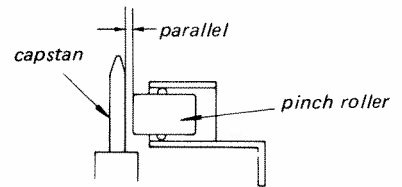

2. Slowly pull the pinch roller and read the spring scale or the tension gauge just when the pinch roller stops rotating.

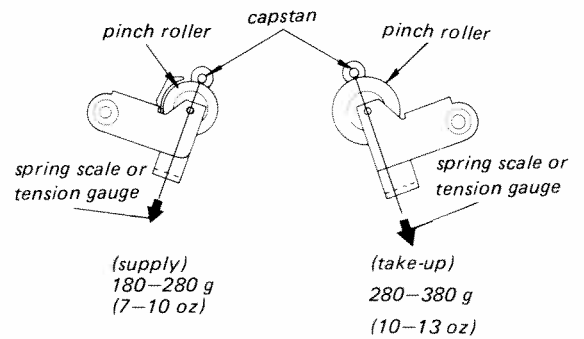

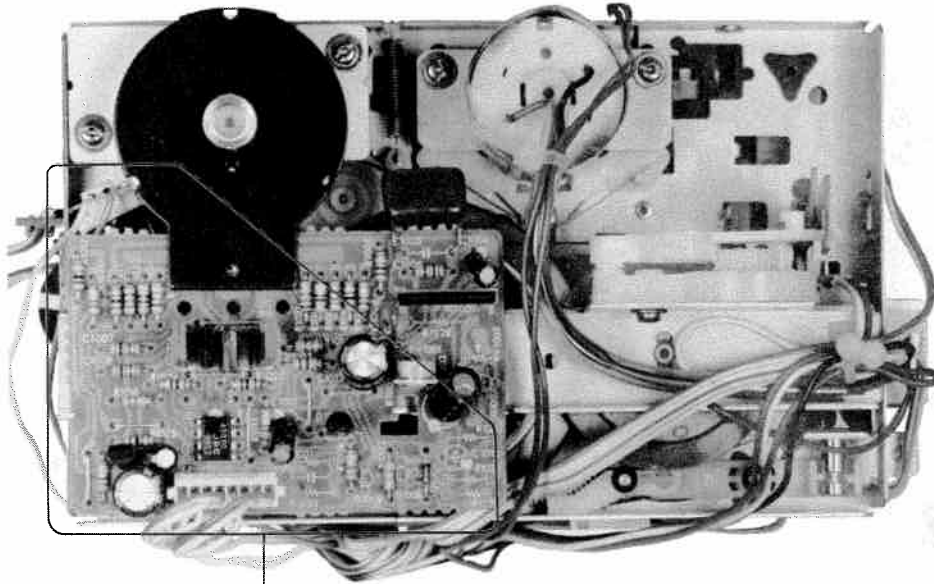

Brake Solenoid (PM1) Position Adjustment

— Stop Mode —

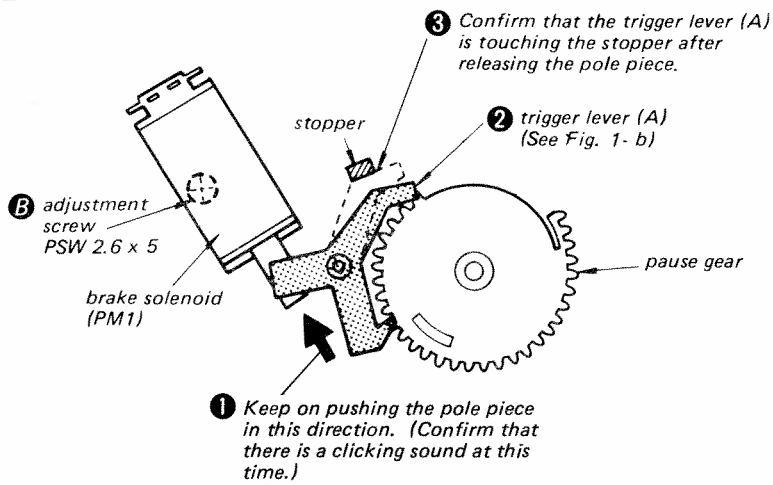

Fig. 1-a

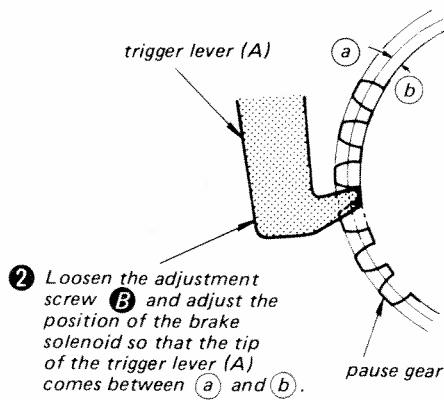
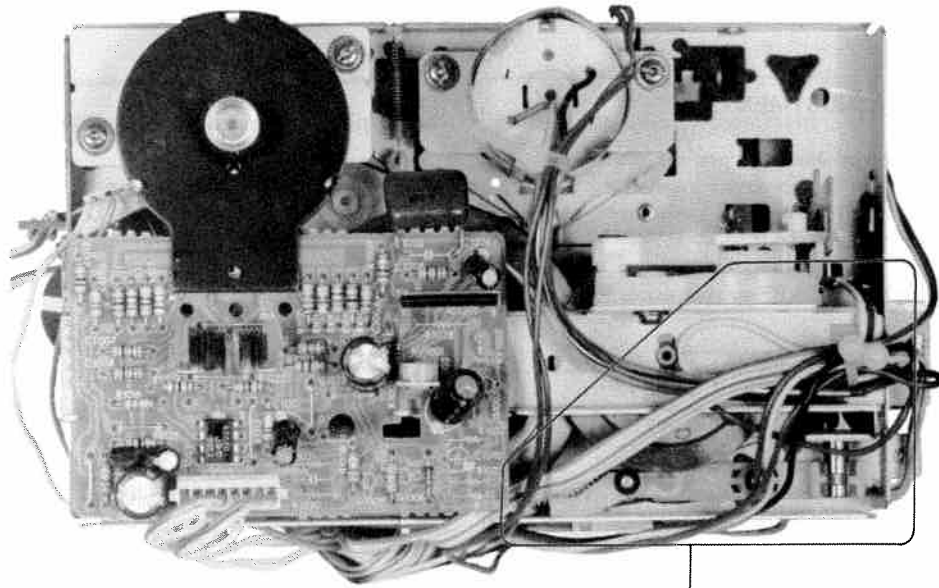

Fig. 1-b



Head Solenoid (PM2) Position Adjustment
 — Stop Mode —

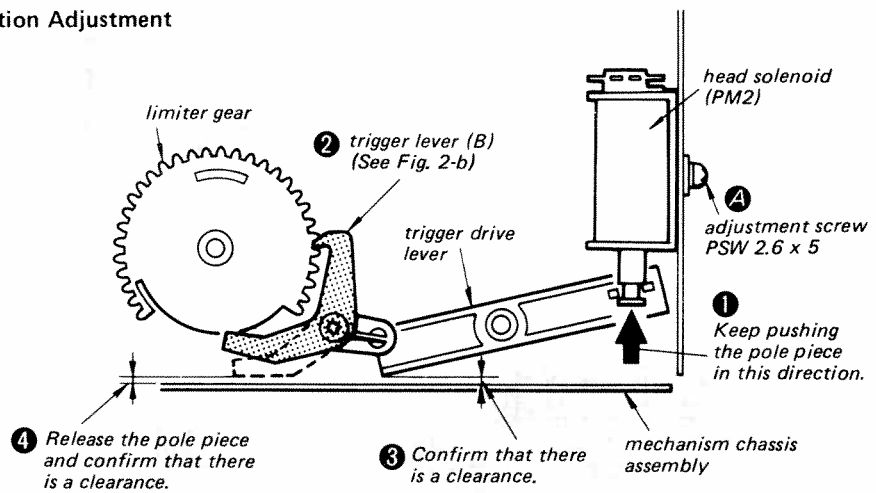
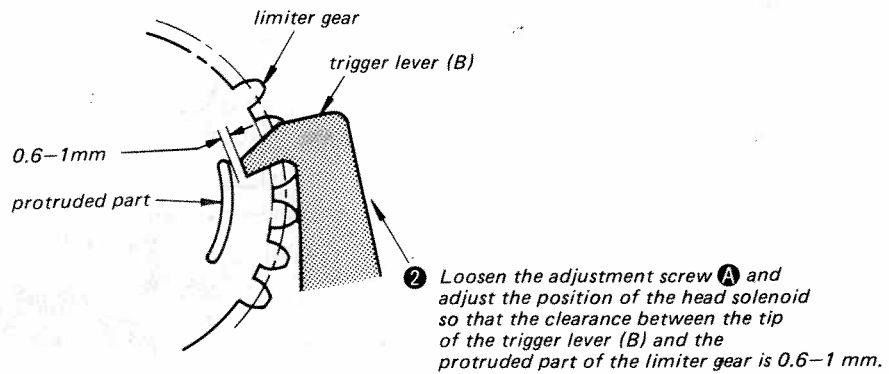

Fig. 2-a



3-2. ELECTRICAL ADJUSTMENTS

Note: The adjustment should be performed in the order given in this service manual. The adjustments should be performed for both L-CH and R-CH.

- Set the BIAS knob and TAPE switch according to the tape as follows.

Tape	BIAS knob	TAPE switch
CS-10	mechanical-mid	TYPE I
CS-25		TYPE II
CS-30		TYPE III
CS-40		TYPE IV

- Switches and controls should be set as follows unless otherwise specified.

DOLBY NR switch: OFF
 TAPE switch: TYPE I
 MONITOR switch: TAPE
 BIAS knob: mechanical-mid

- Standard Record:

Deliver the standard input signal level to the input jack and set the REC LEVEL control to obtain the standard output signal level.

Standard Input Level

	MIC	LINE IN
source impedance	300 Ω	10 k Ω
input level	0.77 mV (-60 dB)	0.25 V (-10 dB)

Standard Output Level

	LINE OUT	HEAD-PHONES
load impedance	47 k Ω	8 Ω
output level	0.44 V (-5 dB)	77 mV* (-20 dB)

*with LINE OUT/PHONES level control at "0".

Record/playback Head Azimuth Adjustment

Procedure:

- Mode: playback

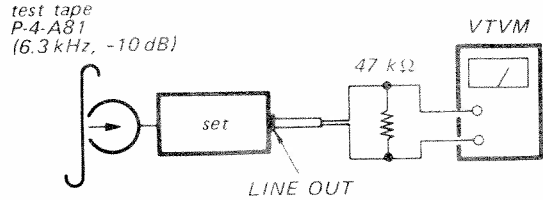

- Turn the adjustment screw for the maximum output levels. If these levels do not match, turn the adjustment screw until both of output levels match together within 0.5 dB.

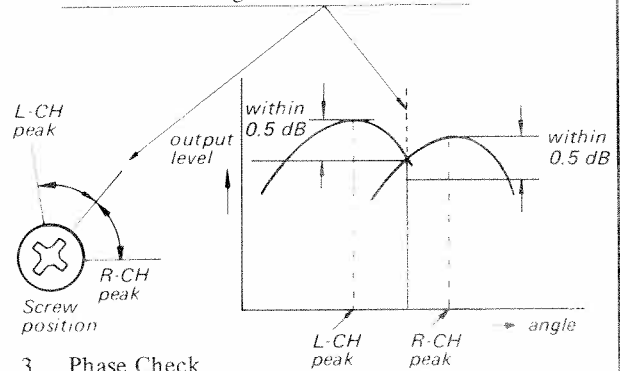

- Phase Check

Mode: playback

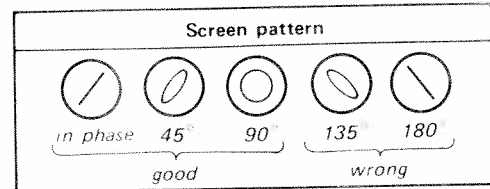
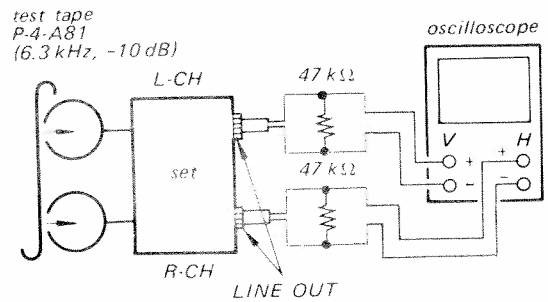

Adjustment Location:

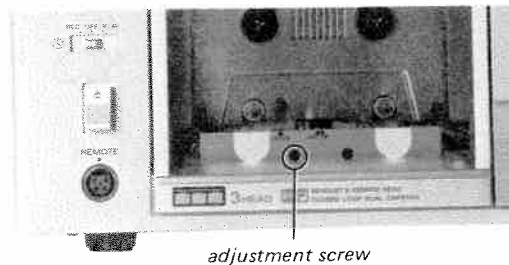

Tape Speed Adjustment

Procedure:

Mode: playback

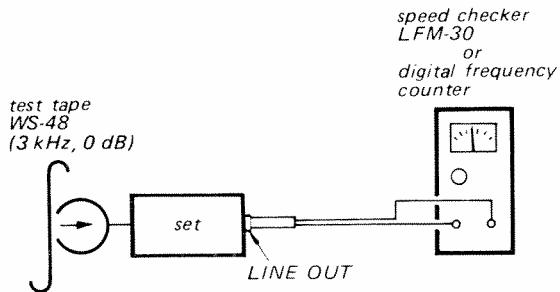

Specification:

Speed checker	Digital frequency counter
-0.7 to +0.7%	2.980 ~ 3.020 Hz

Frequency difference between the beginning and the end of the tape should be within 0.7% (20 Hz).

Adjustment Location:

— servo amp board —

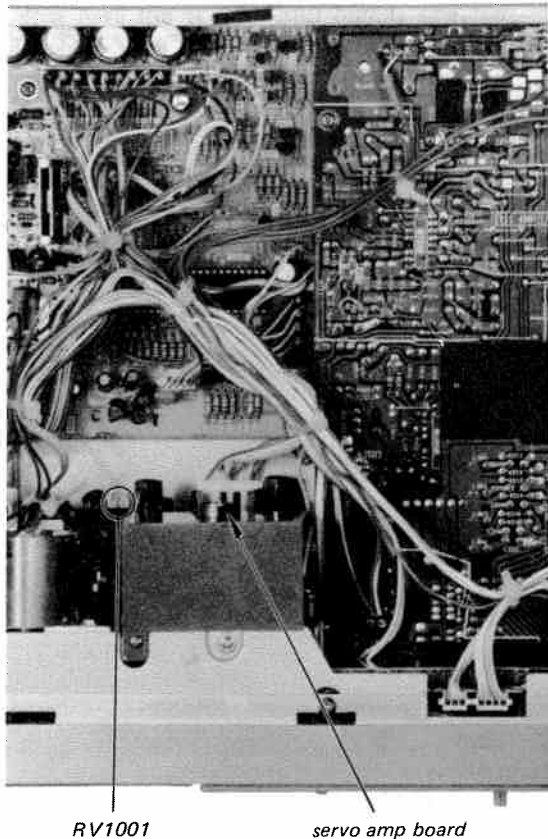

Playback Level Adjustment

Procedure:

Mode: playback

test tape
P-4-L81
(333 Hz, 0 dB)

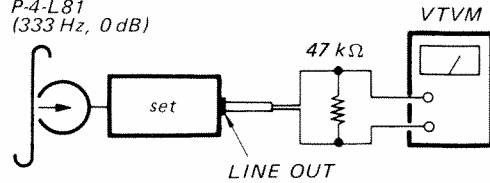

Specification:

LINE OUT level: 0.52 – 0.59 V
(–3.5 to –2.5 dB)

Level difference between channels:
less than 0.5 dB

Check that LINE OUT level does not change in playback mode while changing the mode from playback to stop several times.

Adjustment Location:

— record/playback board —

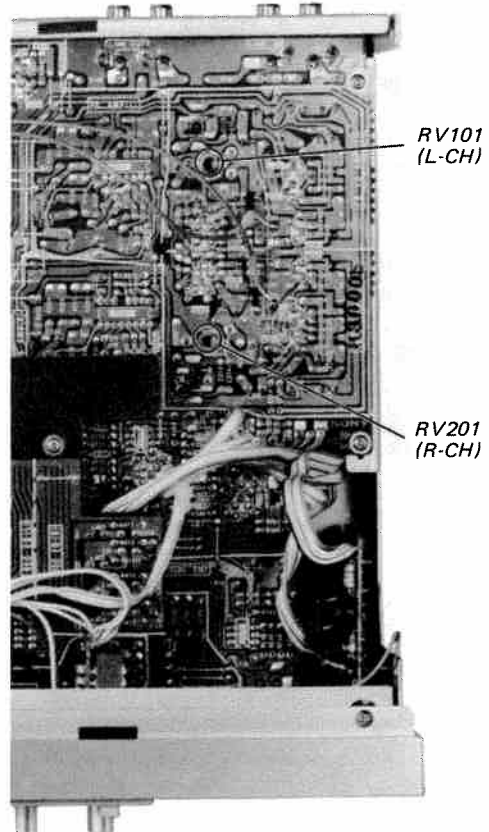

Bias Trap Adjustment

Setting:

TAPE switch: TYPE IV (METAL)

Procedure:

Mode: record (no-cassette loaded)

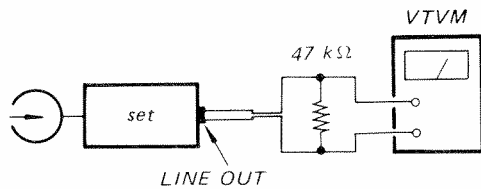

Specification:

LINE OUT level: less than 2.5 mV
(less than - 50 dB)

Adjustment Location:

– record/playback board –

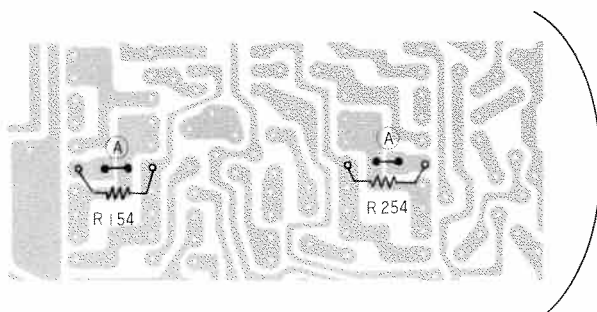
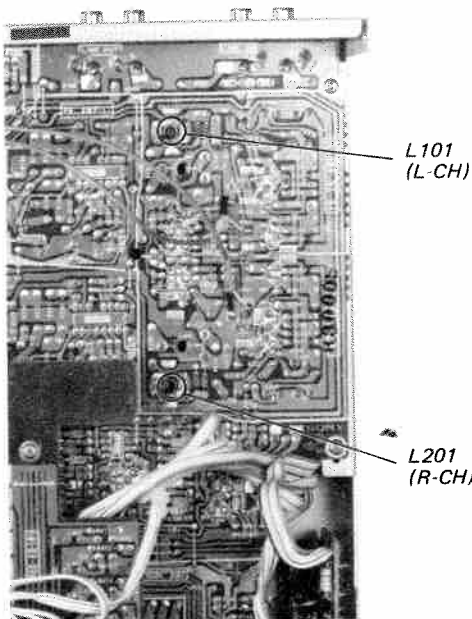

LED Peak Program Meter Calibration

Setting:

REC LEVEL control: standard record
(See page 16.)

MONITOR switch: SOURCE

Procedure:

1. Mode: record

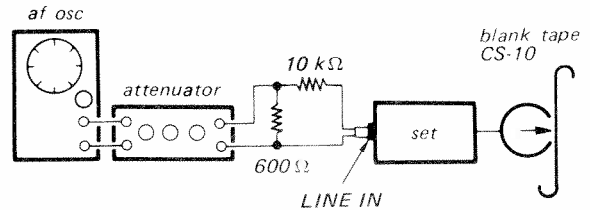

Just after the element at -2 dB (■ mark) turned off, adjust RV103 (L-CH) and RV203 (R-CH) so that the element at 0 VU (-4 dB) keeps turning on.

2. Increase the LINE IN level to +2 dB ±1 dB (0.85 – 1.1 V). The right-most element at +8 dB should turn on.
3. Decrease the LINE IN level to -46 dB ±3 dB (2.7 – 5.5 mV). The second element from the left end should turn off. If not even with a LINE IN level of -49 dB (2.7 mV), bridge the patterns as follows (marked (A)).

Adjustment Location:

– record/playback board –

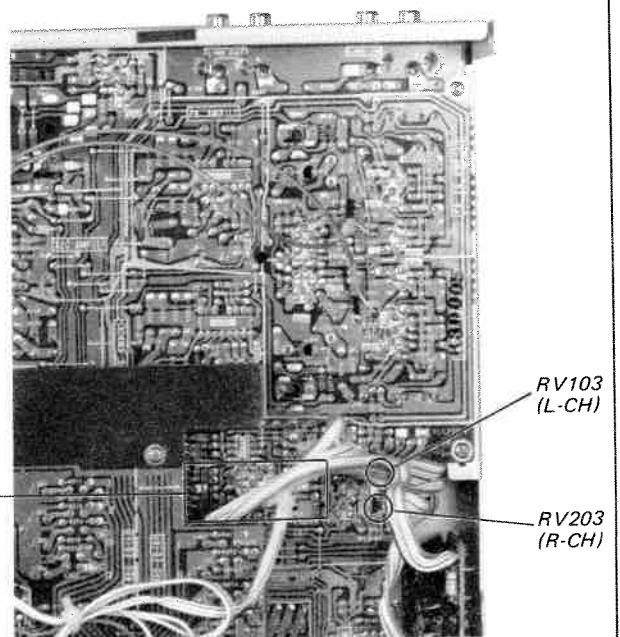

Record Bias Adjustment

Setting:

REC LEVEL control: standard record
(See page 16.)

Procedure:

1. Mode: record

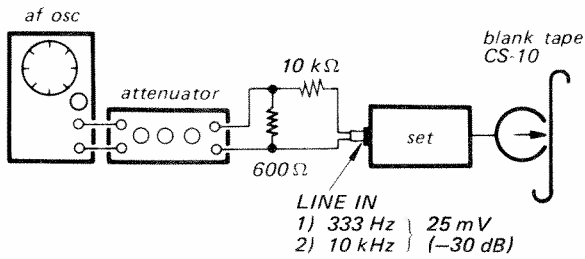

2. Mode: playback

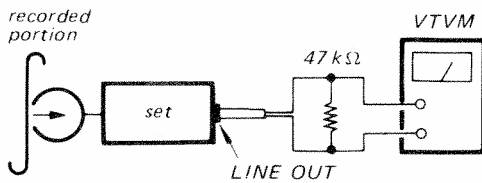

Adjust C152 (L-CH) and C252 (R-CH) so that the 333 Hz and the 10 kHz signal levels become the same.

Adjustment Location:

– record/playback board –

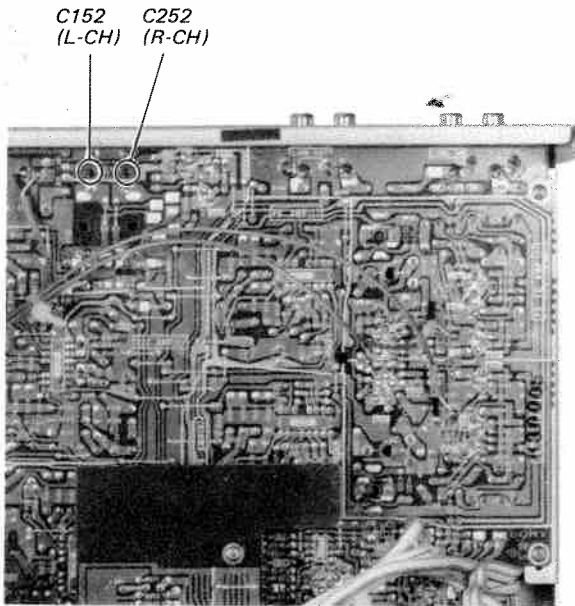

Record Level Adjustment

Setting:

REC LEVEL control: standard record
(See page 16.)

Procedure:

1. Mode: record blank tape
CS-10
CS-25
CS-30
CS-40

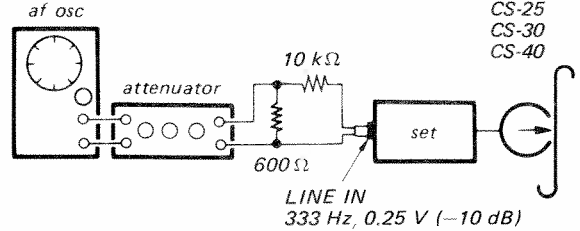

2. Mode: playback

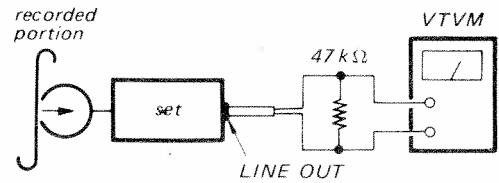

Specification:

Tape	LINE OUT level
CS-10	0.41 – 0.46 V (–5.5 to –4.5 dB)
CS-25 CS-30 CS-40	0.39 – 0.48 V (–6 to –4 dB)

Adjustment Location:

– record/playback board –

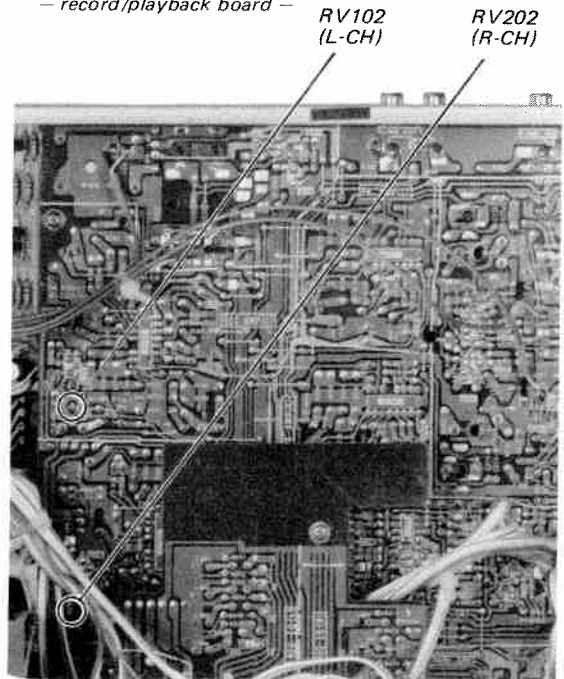

SECTION 4
DIAGRAMS

Motor Gain Adjustment

1. Unsolder the pattern connection (marked **a**) on the servo amp board.
2. Connect the regulated power supply as shown below.
3. If the motor does not start rotating even when the POWER switch is turned ON, rotate the motor by hand.
4. Connect VOM to H1 and change the pattern connection for 4.25 V ac reading on VOM or adjust RV1003 for 4.25V ac reading on VOM.
5. Connect VOM to H2 and change the pattern connection for 4.25 V ac reading on VOM or adjust RV1004 for 4.25V ac reading on VOM.
6. After the adjustment, solder the pattern unsoldered in step 1.

- US model: serial No. up to 802,000.
- Canadian model: serial No. up to 700,500.
- AEP model: serial No. up to 502,500.
- UK model: serial No. up to 600,500.

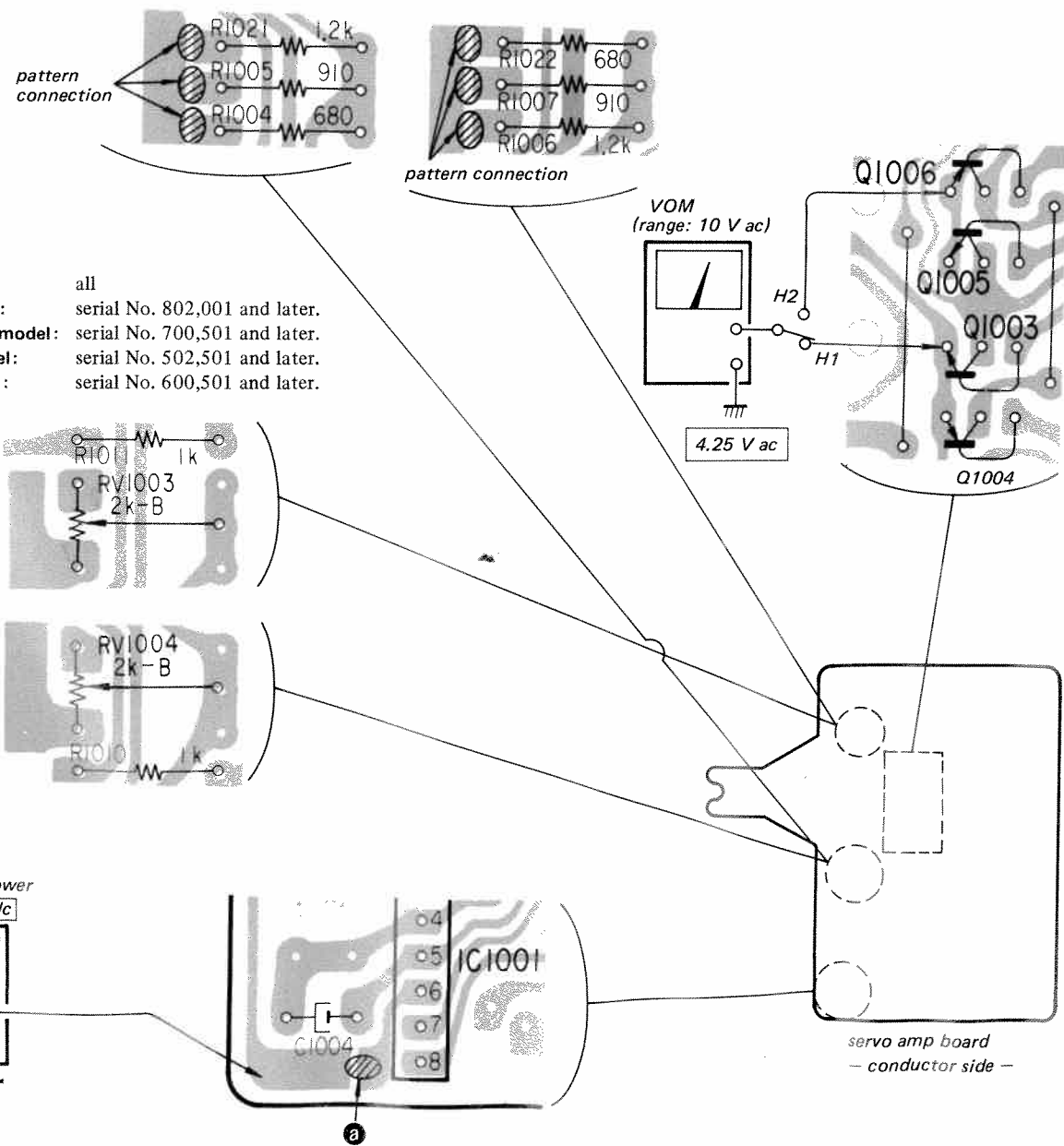

- E model: all
- US model: serial No. 802,001 and later.
- Canadian model: serial No. 700,501 and later.
- AEP model: serial No. 502,501 and later.
- UK model: serial No. 600,501 and later.

Voltages and Waveforms at the Terminals of IC801.

Terminal No.	Waveform or Voltage	Terminal No.	Waveform or Voltage	Terminal No.	Waveform or Voltage
1		14	Forward or Fast Forward Mode 	30	 Fast Forward button is pushed.
2	 Rewind button is pushed.	15	Record Mode 	31	 Rewind button is pushed.
3	 Stop button is pushed or the cassette lid is open.	16	Pause Mode 	32	S6 (timer): REC 0.6 Vdc
4	 Forward button is pushed.	17	0Vdc	33	S6 (timer): PLAY 0 Vdc
5	 Fast Forward button is pushed.	18	0Vdc	34	 0V: when the tape counter indicates "999" in rewind mode.
6	10Vdc	19	Record Mode 	35	
7	 S801 (POWER):ON S801 (POWER):OFF	20, 21	0Vdc	36	• Forward Mode • Fast Forward or Rewind Mode • When pause button is pushed in forward mode: 10 Vdc • Tape End: 10 Vdc
8	 Record button is pushed.	22	Fast Forward or Rewind Mode 	37, 38	10Vdc
9	 Pause button is pushed.	23	8Vdc	39	0Vdc
10	 Record button is pushed.	24	Record/Forward button is pushed. Record Muting or Pause button is pushed. 	40	10Vdc
11	When the accidental erasure prevention tab is broken: 0 V When the accidental erasure prevention tab is not broken: 10 V	25, 26	10Vdc	41	0Vdc
12	10Vdc	27	 Forward, Fast Forward or Rewind button is pushed.	42	
13	Forward Mode 	28	Fast Forward or Rewind Mode 		
		29	Record/Forward button is pushed. 		

hading and mark place only with

ne trame et une a sécurité. Ne les ortant le numéro

noted. pF : µF for electrolytics otherwise noted.

unless otherwise conditions with a

normal produc-

Position
OFF
OFF
OFF
OFF
OFF
OFF
OFF
OFF
OFF
OFF
ON
OFF

of IC801 are differ from the rm on page 21.

4-1. MOUNTING DIAGRAM — System Control Section —

- See page 34 for the Semiconductor Lead Layouts.
- Refer to page 21 for voltages and waveforms at the terminals of IC801.

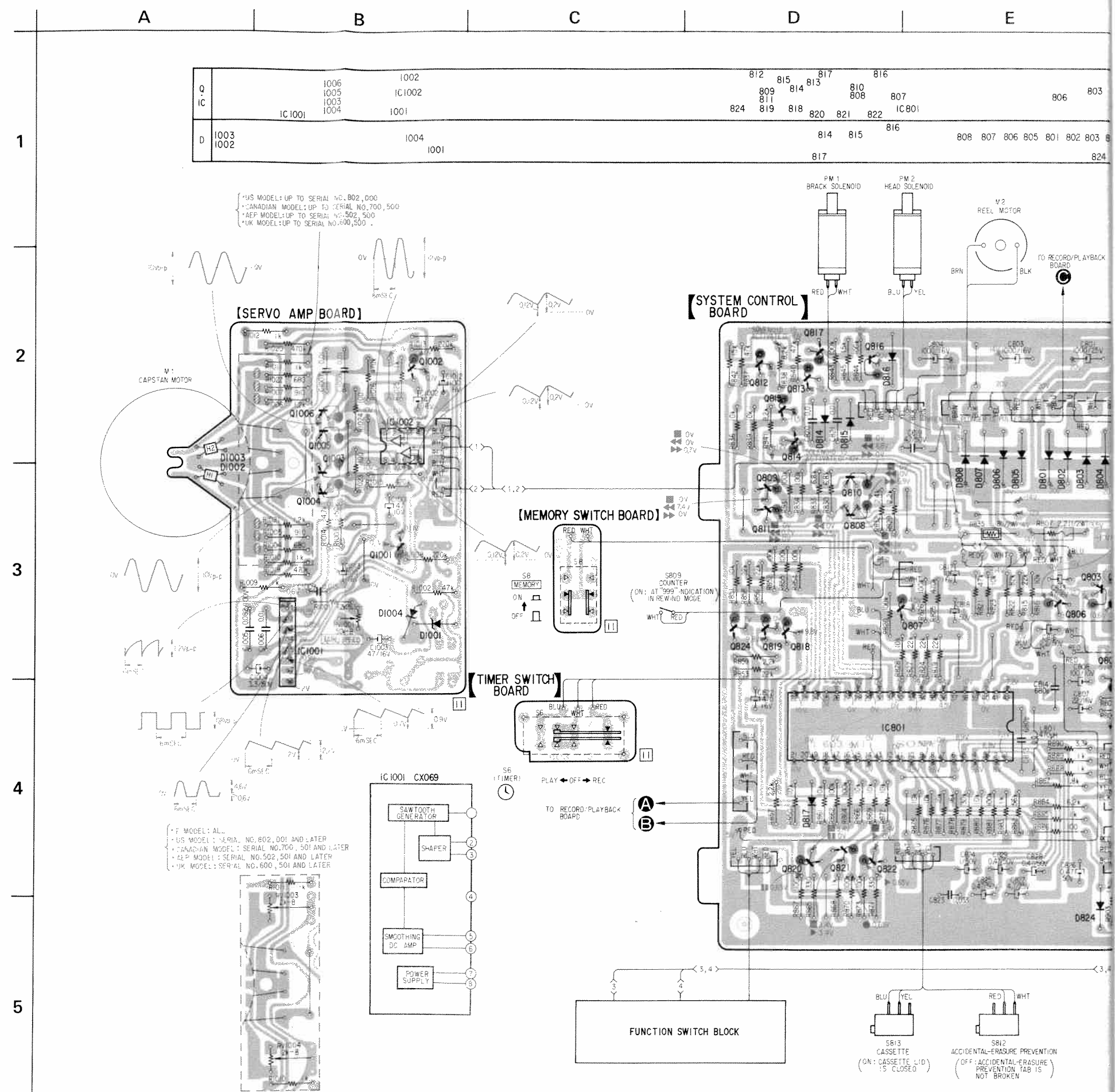

Q	IC	1006 1005 1003 1004	1002 IC1002 1001	812 809 811 819	815 814 818	817 813 820	816 810 808 807 IC801	806 803
D		1003 1002	1004 1001	824	814 815	816	808 807 806 805 801 802 803	824

*US MODEL: UP TO SERIAL NO. 802,000
 *CANADIAN MODEL: UP TO SERIAL NO. 700,500
 *AFP MODEL: UP TO SERIAL NO. 502,500
 *UK MODEL: UP TO SERIAL NO. 600,500

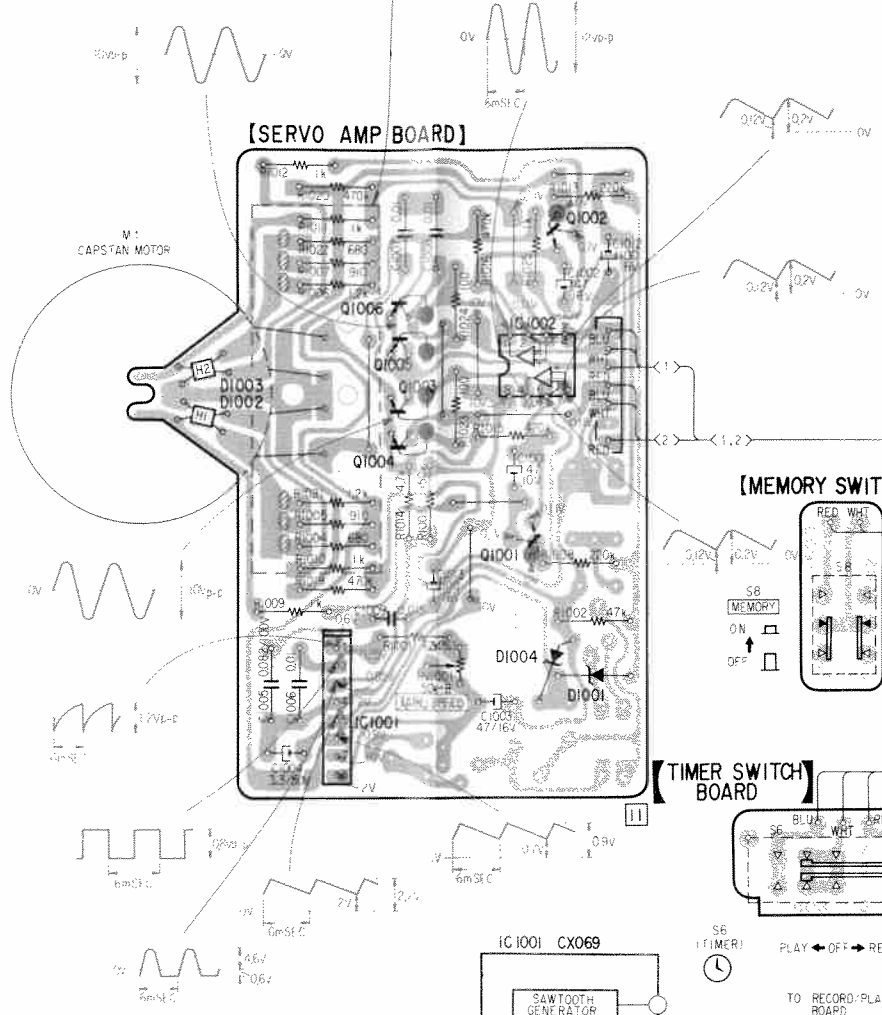

*F MODEL: ALL
 *US MODEL: SERIAL NO. 802,001 AND LATER
 *CANADIAN MODEL: SERIAL NO. 700,501 AND LATER
 *AFP MODEL: SERIAL NO. 502,501 AND LATER
 *UK MODEL: SERIAL NO. 600,501 AND LATER

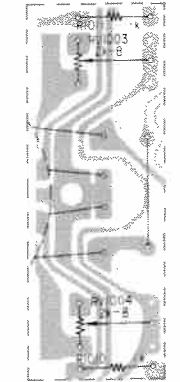

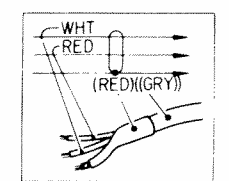

Note:

- Color code of sleeving over the end of the jacket.



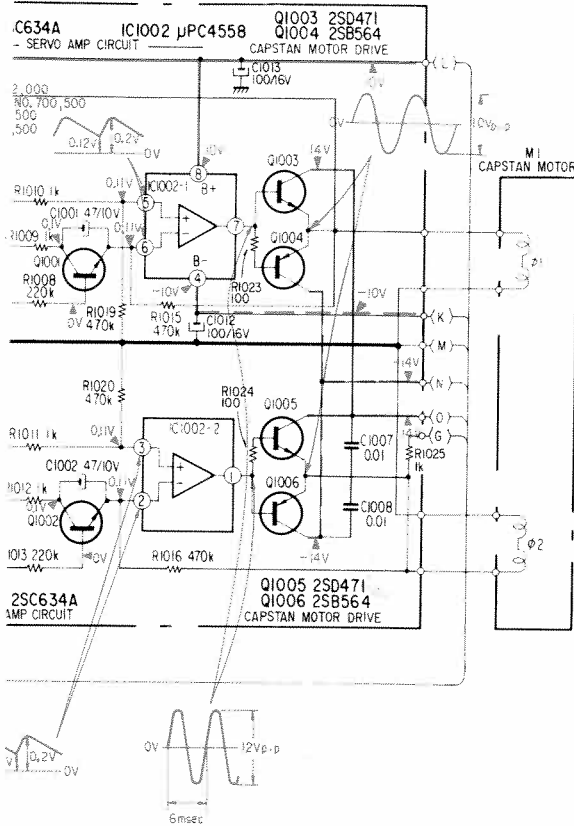





- : B+ pattern
- : B+ pattern
- no mark: STOP
- ▶ : FORWARD
- ▶▶ : FAST FORWARD
- ◀◀ : REWIND
- : RECORD
- : REC MUTE
- || : PAUSE
- : STOP



Note: The components identified by shading and mark  are critical for safety. Replace only with part number specified.

Note: Les composants identifiés par une trame et une marque  sont critiques pour la sécurité. Ne les remplacer que par une pièce portant le numéro spécifié.

Note:

- All capacitors are in μF unless otherwise noted. $\text{pF} : \mu\mu\text{F}$ 50WV or less are not indicated except for electrolytics and tantalums.
 - All resistors are in ohms, $\frac{1}{4}\text{W}$ unless otherwise noted. $\text{k}\Omega : 1000\Omega$, $\text{M}\Omega : 1000\text{k}\Omega$
 -  : nonflammable resistor.
 -  : fusible resistor.
 -  : panel designation.
 -  : adjustment for repair.
 -  : B+ bus.
 -  : B- bus.
 - Voltages are dc with respect to ground unless otherwise noted.
 - Readings are taken under no-signal conditions with a VOM (20 $\text{k}\Omega/\text{V}$).
- no mark: STOP
- ▶ : FORWARD
 - ▶▶ : FAST FORWARD
 - ◀◀ : REWIND
 - : RECORD
 - : REC MUTE
 - || : PAUSE
 - : STOP

- Voltage variations may be noted due to normal production tolerances.
- Switches

Ref. No.	Switch	Position
S6	TIMER	OFF
S8	MEMORY	OFF
S801	POWER	OFF
S802	REWIND	OFF
S803	STOP	OFF
S804	FORWARD	OFF
S805	FAST FORWARD	OFF
S806	RECORD	OFF
S807	PAUSE	OFF
S808	REC MUTE	OFF
S809	TAPE COUNTER	OFF
S810	MEMORY	OFF
S811	TIMER	OFF
S812	ACCIDENTAL ERASURE PREVENTION	ON
S813	CASSETTE	OFF

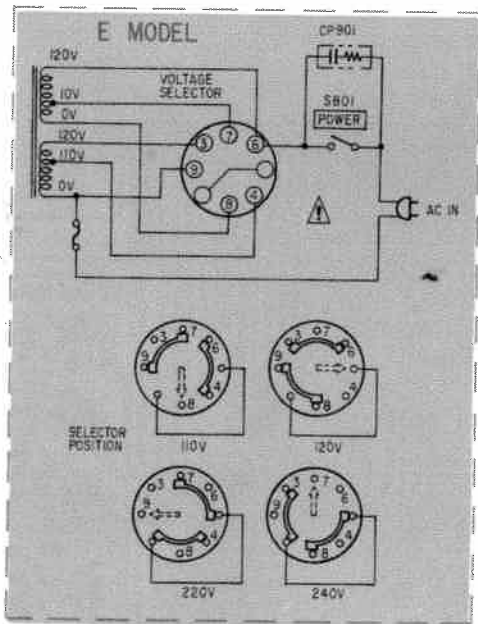

Note:The voltages at the terminals of IC801 are measured with a VOM and differ from the voltages given beside the waveform on page 21.

4-3. MOUNTING DIAGRAM
- Audio Amp Section -

• See page 34 for the Semiconductor Lead Layouts.

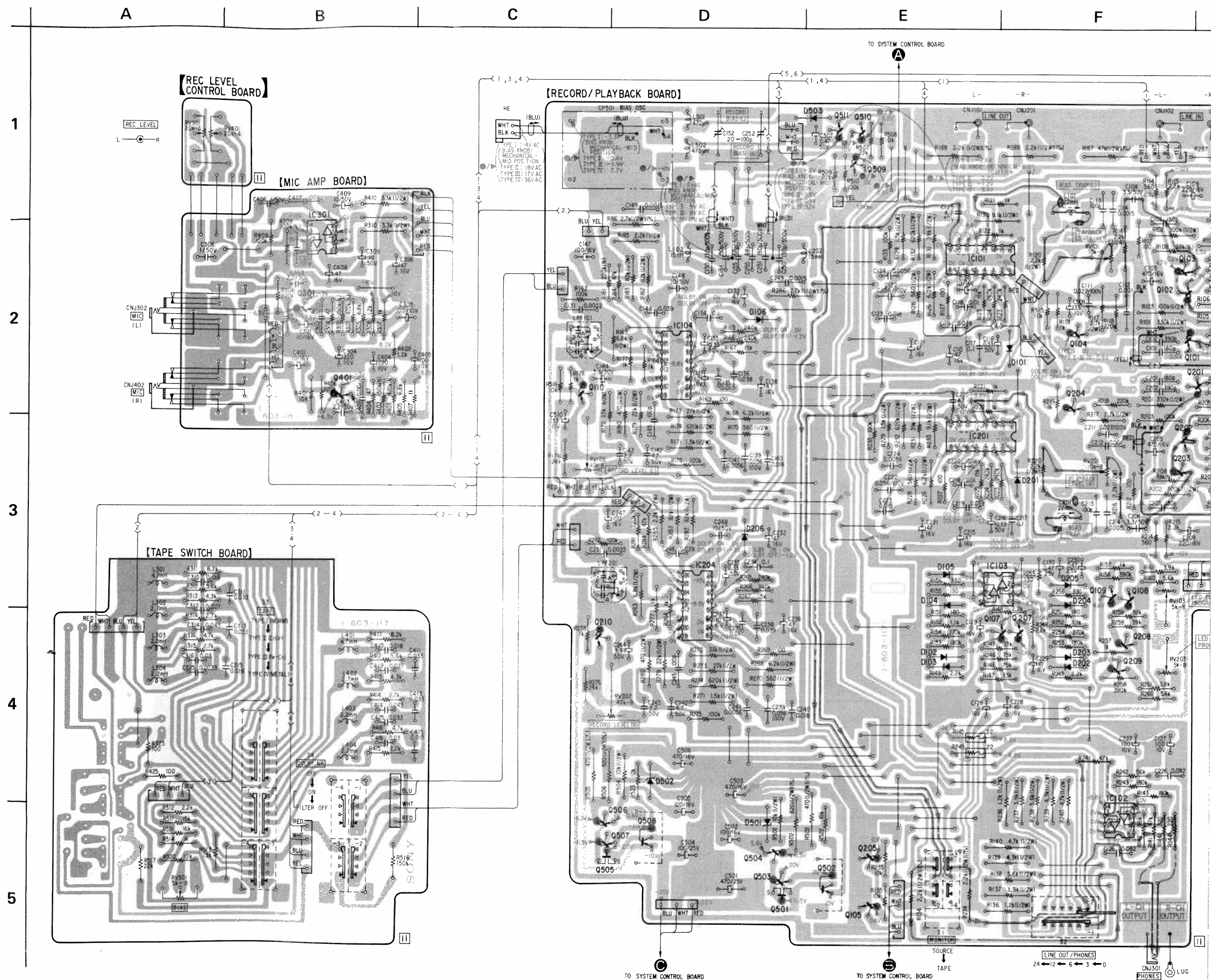

Note:
• Color code of sleeving over the end of the jacket.

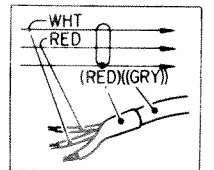

- : B+ pattern
- : signal path
- : L-CH signal path
- : R-CH signal path
- no mark: STOP
- ▶ : FORWARD
- ▶▶ : FAST FORWARD
- ◀◀ : REWIND
- : RECORD
- : REC MUTE
- : PAUSE
- : STOP

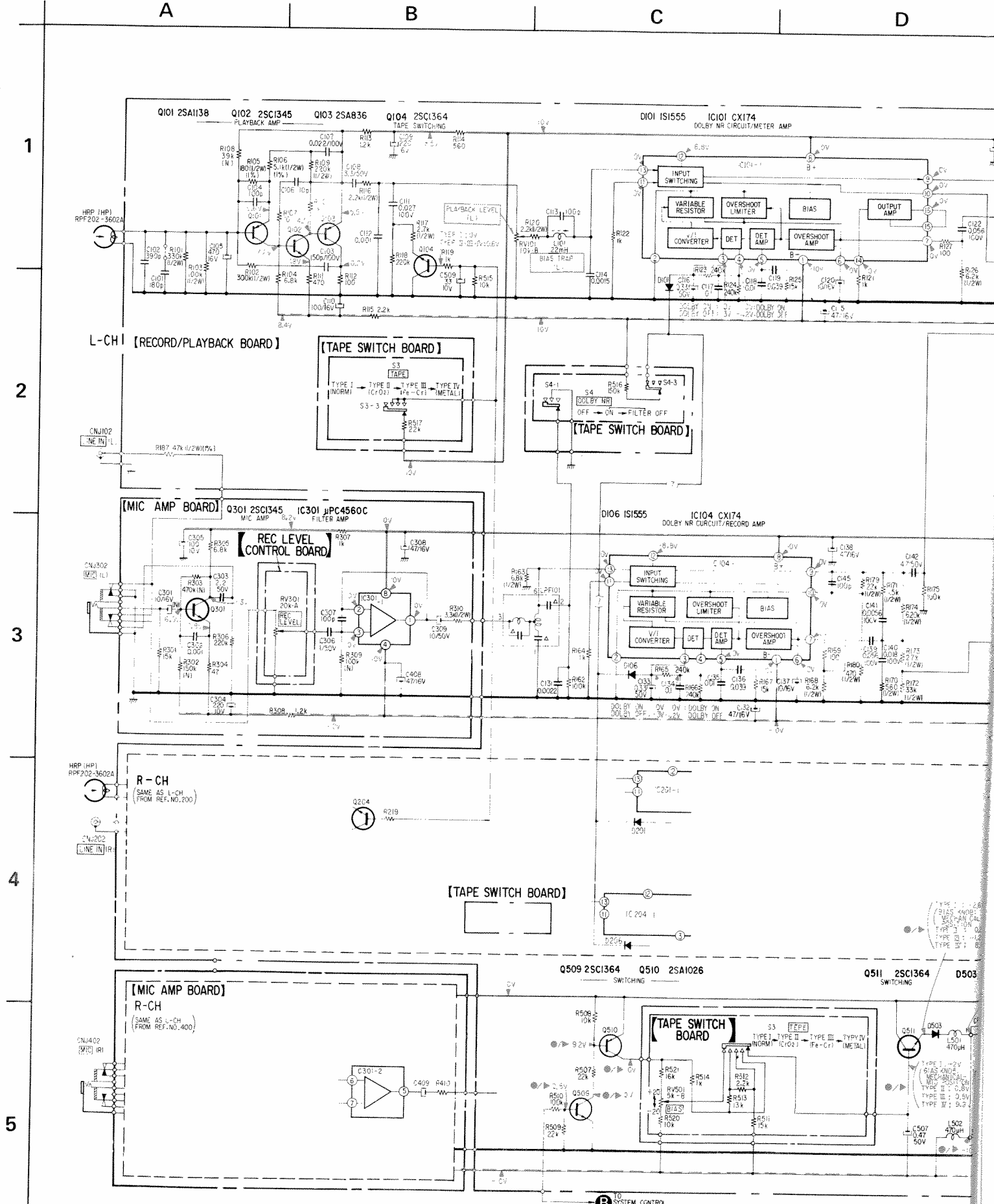
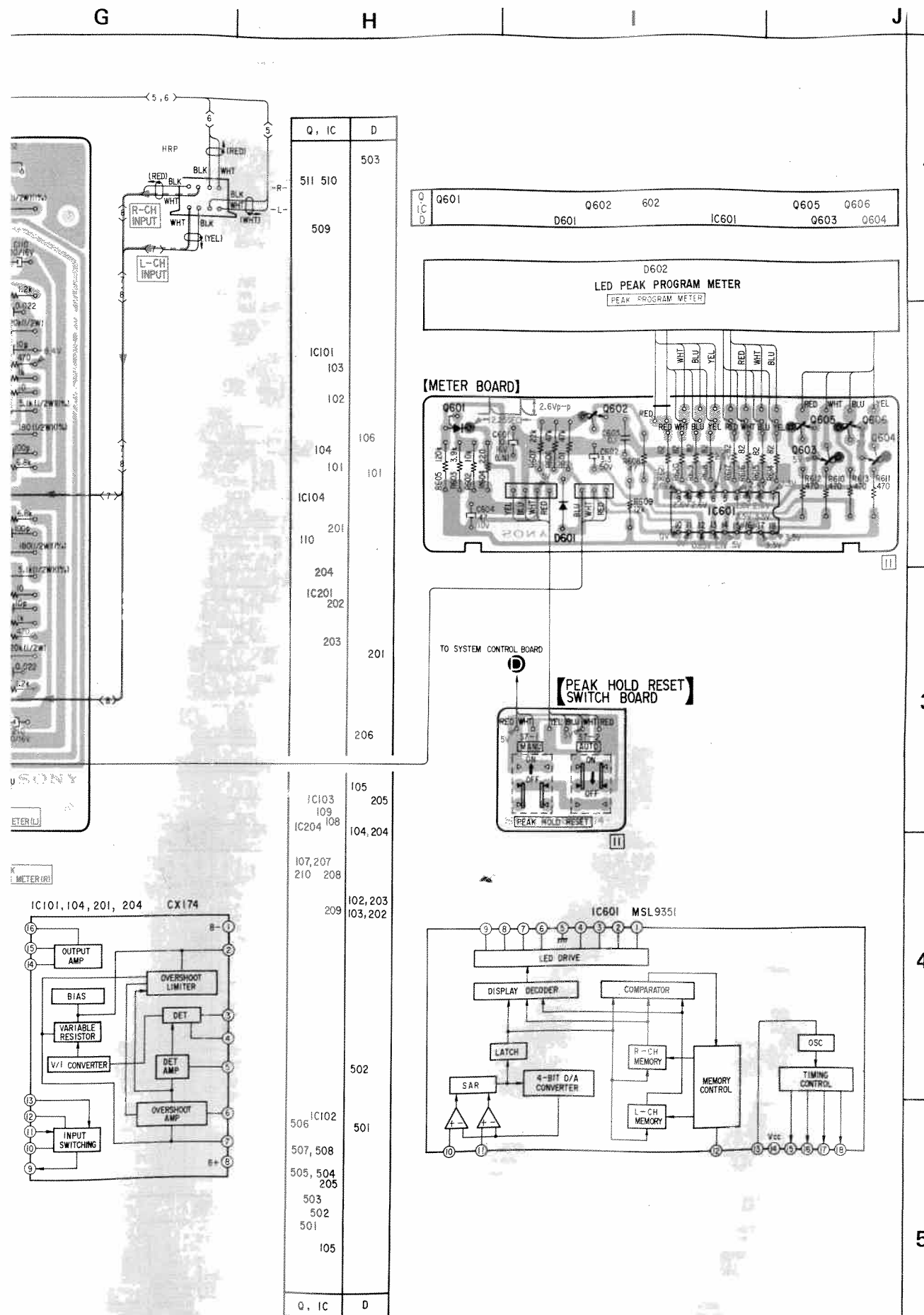

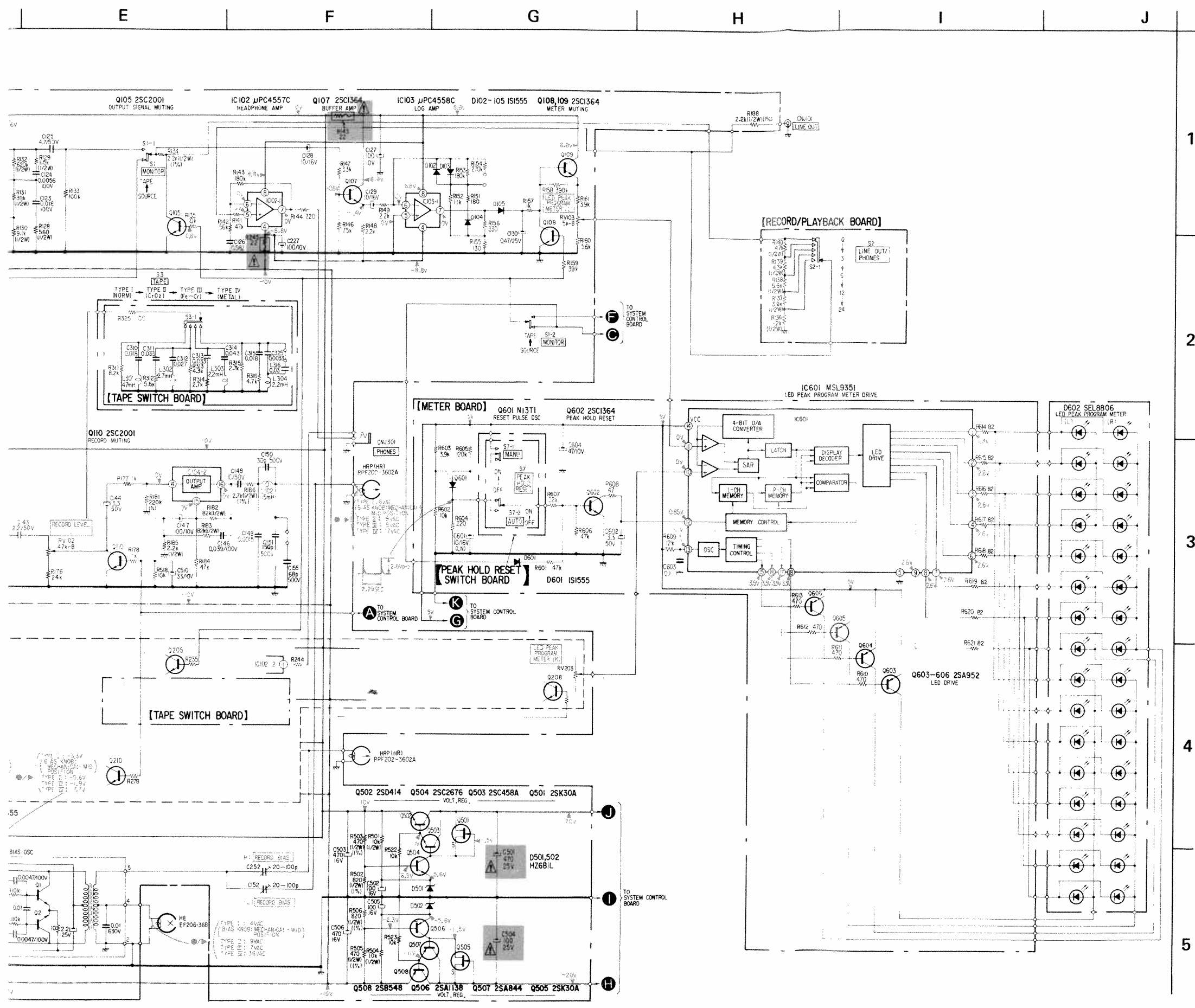

Note: The components identified by shading and mark are critical for safety. Replace only with part number specified.

Note: Les composants identifiés par une trame et une marque sont critiques pour la sécurité. Ne les remplacer que par une pièce portant le numéro spécifié.

- Note:
- Components for right channel have same values as for left channel. Reference numbers are coded from
 - 2 • All capacitors are in μF unless otherwise noted. pF : μF 50WV or less are not indicated except for electrolytics and tantalums.
 - All resistors are in ohms, $\frac{1}{4}\text{W}$ unless otherwise noted. $\text{k}\Omega$: 1000 Ω , $\text{M}\Omega$: 1000 $\text{k}\Omega$
 - : panel designation.
 - : adjustment for repair.
 - : B+ bus.
 - : B- bus.
 - Voltages are dc with respect to ground unless otherwise noted.
 - Readings are taken under no-signal conditions with a VOM (20 $\text{k}\Omega/\text{V}$).
 - no mark: STOP
 - : FORWARD
 - : FAST FORWARD
 - : REWIND
 - : RECORD
 - : REC MUTE
 - : PAUSE
 - : STOP
 - Voltage variations may be noted due to normal production tolerances.
 - AC voltage readings in the bias oscillator are taken with a VTVM.
 - Switches

Ref. No.	Switch	Position
S1	MONITOR	SOURCE
S2	LINE OUT/PHONES	24
S3	TAPE	TYPE I (NORM)
S4	DOLBY NR	OFF
S7	PEAK HOLD RESET	AUTO

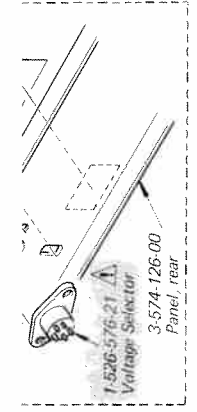

ETWEE OUT /PHONES (S2)
Switch, lever.
MONITOR (S1)

BVTT3 x F
Supplied with jack.
Supplied with switch.

E

D

C

B

A

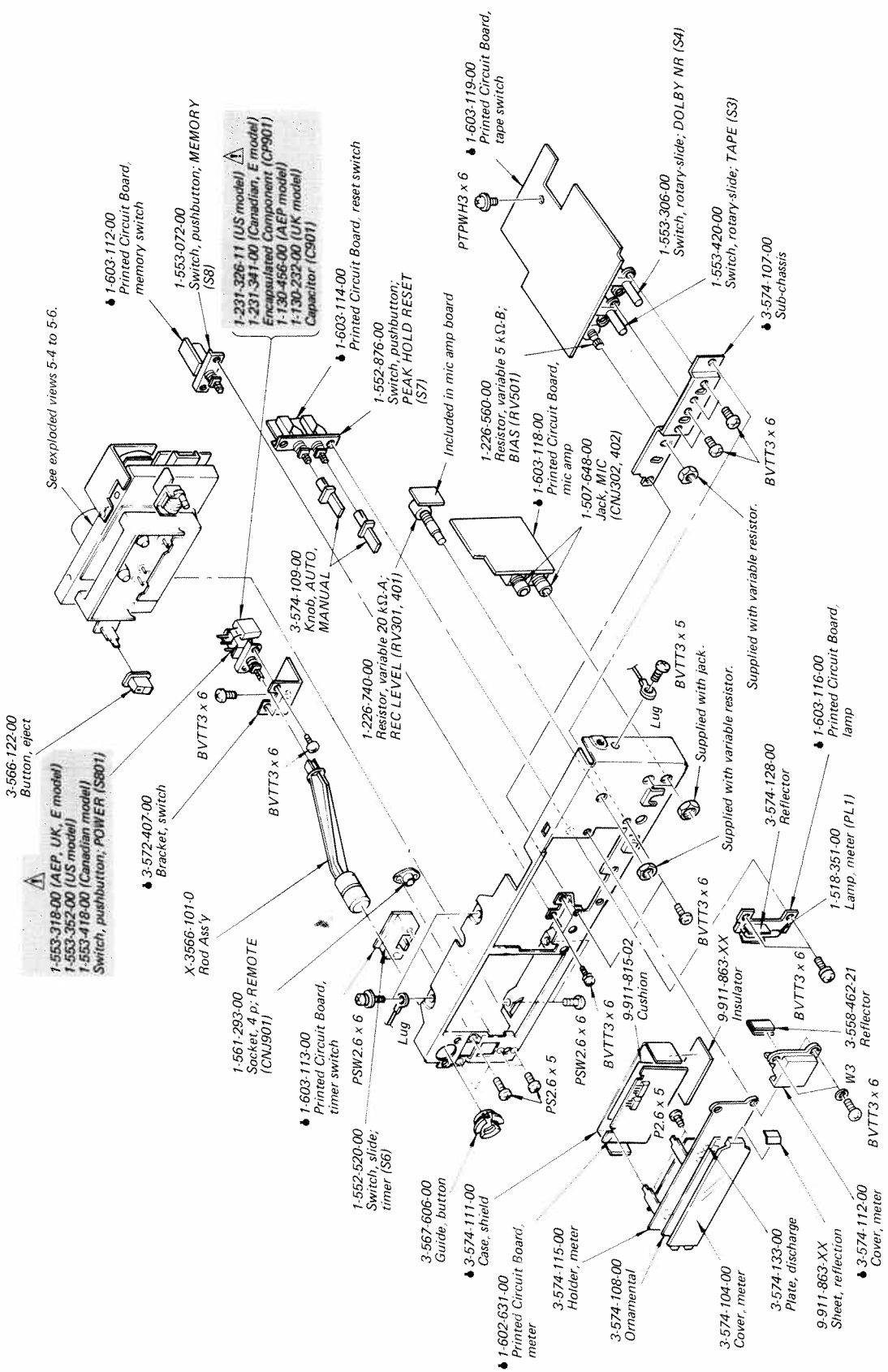

1

2

3

5-3.

A B C D E

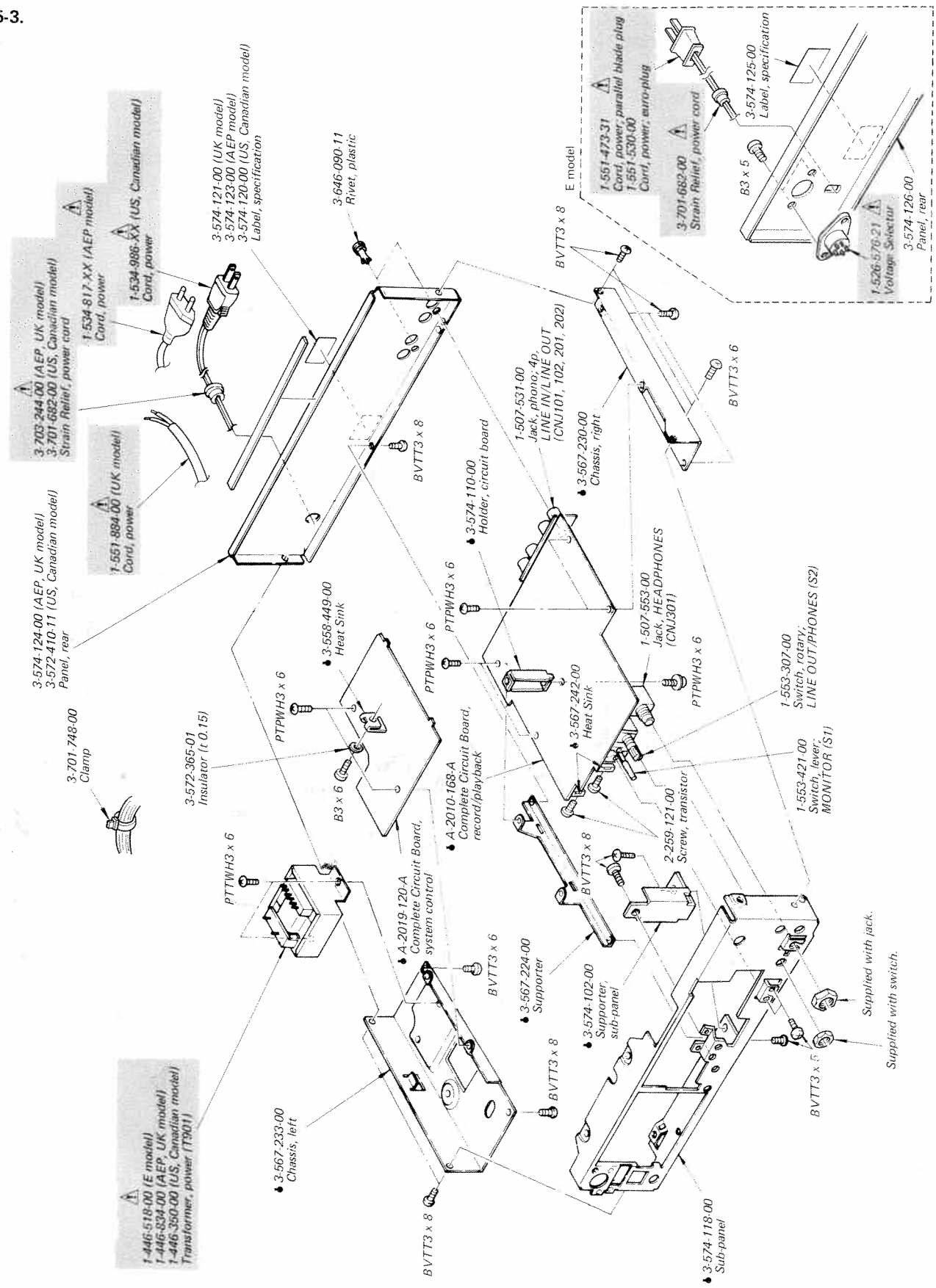

5-6.

A B C D E

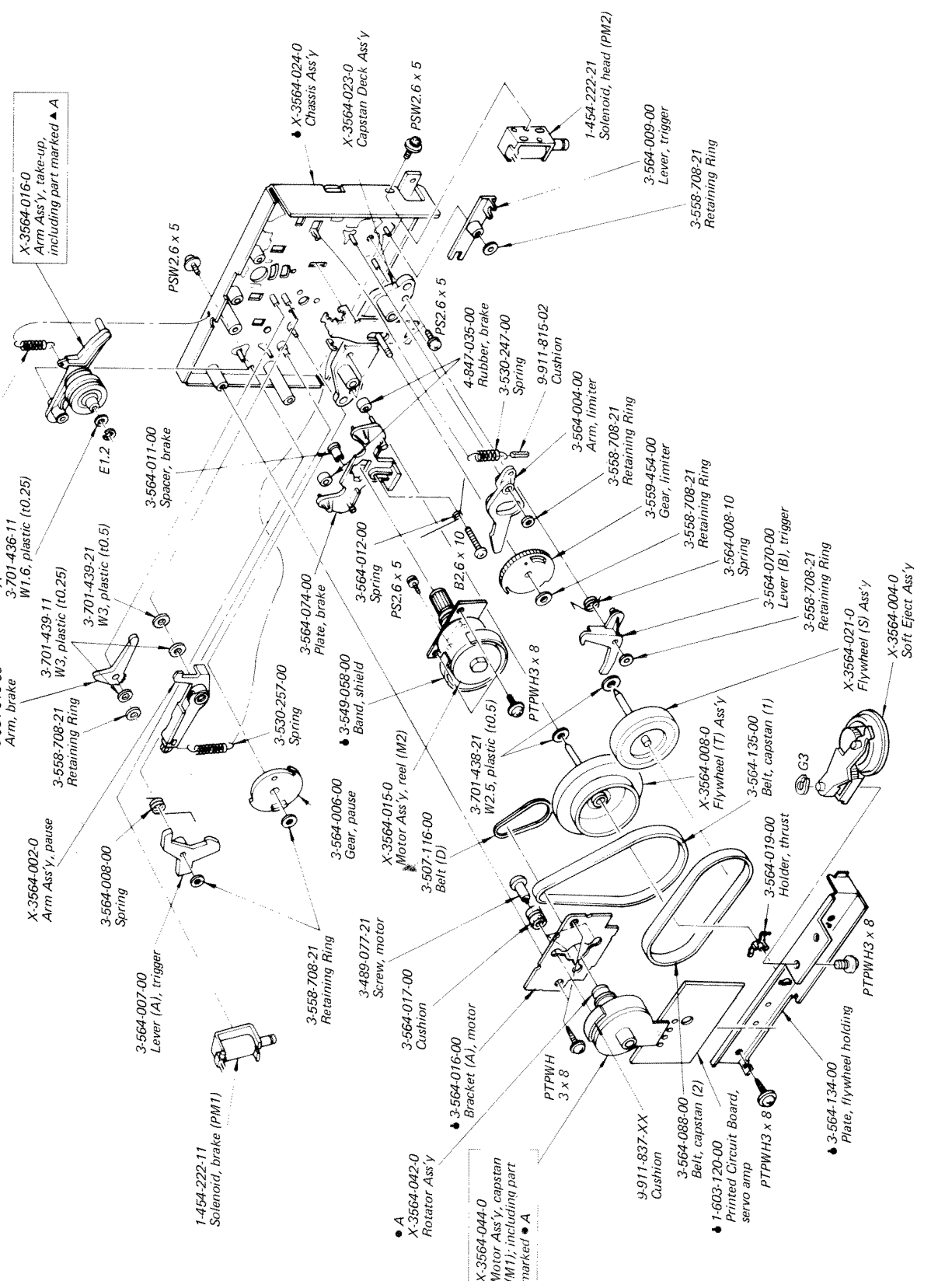

1

2

3

SECTION 6
ELECTRICAL PARTS LIST

• Items marked with a star are not stocked since they are seldom required for routine service. Some delay should be anticipated when ordering these items.

Note: The components identified by shading and mark Δ are critical for safety. Replace only with part number specified.

Note: Les composants identifiés par une trame et une marque Δ sont critiques pour la sécurité. Ne les remplacer que par une pièce portant le numéro spécifié.

Ref. No. Part No. Description

SEMICONDUCTORS

Transistors

Q101, 201	8-729-113-82	2SA1138
Q102, 202	8-729-334-58	2SC1345
Q103, 203	8-729-612-77	2SA1027R
Q104, 204	8-729-663-47	2SC1364
Q105, 205	8-729-100-13	2SC2001
Q107, 207	8-729-663-47	2SC1364
Q108, 208		
Q109, 209		
Q110, 210	8-729-100-13	2SC2001
Q301, 401	8-729-334-58	2SC1345

Q501	8-729-203-04	2SK30A
Q502	8-729-141-43	2SD414
Q503	8-729-663-47	2SC1364
Q504	8-729-167-62	2SC2676
Q505	8-729-203-04	2SK30A

Q506	8-729-113-82	2SA1138
Q507	8-729-612-77	2SA1027R
Q508	8-729-154-83	2SB548
Q509	8-729-663-47	2SC1364
Q510	8-729-612-77	2SA1027R

Q511	8-729-663-47	2SC1364
Q601	8-729-101-31	N13T1
Q602	8-729-663-47	2SC1364
Q603-606	8-729-195-23	2SA952
Q801	8-729-180-93	2SD809

Q802	8-729-663-47	2SC1364
Q803, 804	8-729-173-13	2SB731
Q805	8-729-101-13	PH103
Q806, 807	8-729-663-47	2SC1364
Q808	8-729-180-93	2SD809

Q809	8-729-100-13	2SC2001
Q810	8-729-180-93	2SD809
Q811	8-729-100-13	2SC2001
Q812	8-729-612-77	2SA1027R
Q813, 814	8-729-801-22	2SD1012
Q815	8-729-612-77	2SA1027R

Ref. No. Part No. Description

Q816	8-729-374-02	2SB740
Q817	8-729-663-47	2SC1364
Q818, 819	8-729-612-77	2SA1027R
Q820-822	8-729-663-47	2SC1364
Q823	8-729-612-77	2SA1027R

Q824	8-729-663-47	2SC1364
Q1001		
Q1002		
Q1003	8-760-335-10	2SC1474
Q1004	8-729-156-43	2SB564

Q1005	8-760-335-10	2SC1474
Q1006	8-729-156-43	2SB564

ICs

IC101, 201	8-759-101-74	CX174
IC102	8-759-145-57	μ PC4557C
IC103	8-759-145-58	μ PC4558C
IC104, 204	8-759-101-74	CX174
IC301	8-759-145-58	μ PC4558C
IC601	8-759-993-51	MSL9351
IC801	8-759-147-73	μ PD547C-073
IC802	8-759-984-69	MB84069B
IC803	8-759-133-90	μ PC339C
IC804	8-759-145-58	μ PC4558C

IC1001	8-750-690-00	CX069
IC1002	8-759-145-58	μ PC4558C

Diodes

D101-106	8-719-815-55	1S1555
D201-206		
D501, 502	8-719-910-65	HZ6B2L
D503	8-719-815-55	1S1555
D601		

D602	1-800-822-11	SEL8806
D801-808	8-719-200-02	10E2
D809	8-719-910-15	HZ11B2L
D810	8-719-910-25	HZ12B2L
D811	8-719-200-02	10E2
D812	8-719-815-55	1S1555

Ref. No. Part No. Description

D813	8-719-101-11	SR110
D814, 815	8-719-815-55	1S1555
D816, 817	8-719-200-02	10E2
D819	8-719-317-41	SEL1741Y
D820	8-719-311-12	SEL1112R

D821	8-719-313-31	SEL1331G
D822-824	8-719-815-55	1S1555
D825	8-719-910-15	HZ11B2L
D1001	8-719-911-65	HZ6B2LTP
D1002	8-719-841-01	F1410
D1003		
D1004	8-719-147-77	RD4.7E

CAPACITORS

All capacitors are in μ F. Common capacitors are omitted. Refer to the lists on pages 45 and 46 for their part numbers. p: μ F, elect: electrolytic

C103, 203	1-107-304-00	150 p	100 V	silvered mica
C107, 207	1-130-305-00	0.022	100 V	film
C108, 208	1-123-231-00	3.3	50 V	elect (nonpolarized)
C111, 211	1-130-307-00	0.027	100 V	film
C116, 216	1-123-609-00	0.33	50 V	elect

C122, 222	1-130-341-00	0.056	100 V	film
C123, 223	1-130-340-00	0.018	100 V	film
C124, 224	1-130-291-00	0.0056	100 V	film
C125, 225	1-123-232-00	4.7	50 V	elect (nonpolarized)
C133, 233	1-123-609-00	0.33	50 V	elect

C139, 239	1-130-341-00	0.056	100 V	film
C140, 240	1-130-340-00	0.018	100 V	film
C141, 241	1-130-291-00	0.0056	100 V	film
C142, 242	1-123-232-00	4.7	50 V	elect (nonpolarized)
C143, 243	1-123-230-00	2.2	50 V	elect (nonpolarized)

C146, 246	1-130-311-00	0.039	100 V	film
C148, 248	1-123-234-00	10	50 V	elect (nonpolarized)
C150, 250	1-107-172-00	130 p	500 V	silvered mica

Ref. No. Part No. Description

C151, 251	1-107-173-00	150 p	500 V	silvered mica
C152, 252	1-141-225-00	Trimmer		
C155, 255	1-107-036-00	68 p	500 V	silvered mica
C303, 403	1-123-230-00	2.2	50 V	elect (nonpolarized)
C306, 406	1-123-228-00	1	50 V	elect (nonpolarized)

C501	Δ 1-121-733-00	470	25 V	elect
C504	Δ 1-121-416-00	100	25 V	elect
C801, 802	Δ 1-121-657-00	1000	25 V	elect
C803, 804	Δ 1-121-245-00	1000	16 V	elect
C819	1-123-232-00	4.7	50 V	elect (nonpolarized)

C1005	1-130-134-00	0.082	100 V	film
C901	Δ 1-130-232-00	0.22	300 V	film (UK model)
	Δ 1-130-456-00	0.022	250 V	film (AEP model)
CP901	Δ 1-231-326-11			Encapsulated Component (US model)
	Δ 1-231-341-00			Encapsulated Component (Canadian, E model)

RESISTORS

All resistors are in ohms. Common $\frac{1}{4}$ W carbon resistors are omitted. Refer to the list on page 47 for their part numbers. k Ω : 1000 Ω .

R101, 201	1-244-933-00	330 k	$\frac{1}{2}$ W	carbon
R102, 202	1-244-932-00	300 k	$\frac{1}{2}$ W	carbon
R103, 203	1-244-921-00	100 k	$\frac{1}{2}$ W	carbon
R105, 205	1-214-846-00	180	$\frac{1}{2}$ W	metal-oxide (1%)
R106, 206	1-214-881-00	5.1 k	$\frac{1}{2}$ W	metal-oxide (1%)

R109, 209	1-244-929-00	220 k	$\frac{1}{2}$ W	carbon
R116, 216	1-244-881-00	2.2 k	$\frac{1}{2}$ W	carbon
R117, 217	1-244-883-00	2.7 k	$\frac{1}{2}$ W	carbon
R120, 220	1-244-881-00	2.2 k	$\frac{1}{2}$ W	carbon
R126, 226	1-244-892-00	6.2 k	$\frac{1}{2}$ W	carbon

R128, 228	1-244-867-00	560	$\frac{1}{2}$ W	carbon
R129, 229	1-244-877-00	1.5 k	$\frac{1}{2}$ W	carbon
R130, 230	1-244-896-00	9.1 k	$\frac{1}{2}$ W	carbon
R131, 231	1-244-911-00	39 k	$\frac{1}{2}$ W	carbon
R132, 232	1-244-940-00	620 k	$\frac{1}{2}$ W	carbon

<u>Ref. No.</u>	<u>Part No.</u>	<u>Description</u>		
R134, 234	1-214-872-00	2.2 k	½ W	metal-oxide (1 %)
R136, 236	1-244-875-00	1.2 k	½ W	carbon
R137, 237	1-244-887-00	3.9 k	½ W	carbon
R138, 238	1-244-891-00	5.6 k	½ W	carbon
R139, 239	1-244-888-00	4.3 k	½ W	carbon
R140, 240	1-244-889-00	4.7 k	½ W	carbon
R145, 245	▲1-212-865-00	22	¼ W	fusible
R163, 263	1-244-893-00	6.8 k	½ W	carbon
R168, 268	1-244-892-00	6.2 k	½ W	carbon
R170, 270	1-244-867-00	560	½ W	carbon
R171, 271	1-244-877-00	1.5 k	½ W	carbon
R172, 272	1-244-909-00	33 k	½ W	carbon
R173, 273	1-244-907-00	27 k	½ W	carbon
R174, 274	1-244-940-00	620 k	½ W	carbon
R179, 279	1-244-905-00	22 k	½ W	carbon
R180, 280	1-244-865-00	470	½ W	carbon
R182, 282, R183, 283	1-244-919-00	82 k	½ W	carbon
R185, 285	1-244-881-00	2.2 k	½ W	carbon
R186, 286	1-214-874-00	2.7 k	½ W	metal-oxide (1 %)
R187, 287	1-214-905-00	47 k	½ W	metal-oxide (1 %)
R188, 288	1-214-872-00	2.2 k	½ W	metal-oxide (1 %)
R310, 410	1-244-885-00	3.3 k	½ W	carbon
R501	1-244-897-00	10 k	½ W	carbon
R502	1-214-862-00	820	½ W	metal-oxide (1 %)
R503	1-214-856-00	470	½ W	metal-oxide (1 %)
R504	1-244-897-00	10 k	½ W	carbon
R505	1-214-856-00	470	½ W	metal-oxide (1 %)
R506	1-214-862-00	820	½ W	metal-oxide (1 %)
R801	▲1-213-134-00	180	1 W	metal-oxide (nonflammable)
R802	▲1-206-485-00	82	2 W	metal-oxide (nonflammable)
R804	▲1-247-224-00	220	½ W	carbon (nonflammable)
R807	▲1-212-942-00	2.2	½ W	fusible
R835	▲1-247-198-00	18	½ W	carbon (nonflammable)
R904	▲1-247-240-00	1 k	½ W	carbon (nonflammable)

<u>Ref. No.</u>	<u>Part No.</u>	<u>Description</u>	
R1001	1-214-772-00	62 k	¼ W metal-oxide (1 %)
RV101, 201	1-224-645-XX	10 k-B,	adjustable; playback level
RV102, 202	1-224-647-XX	47 k-B,	adjustable; record level
RV103, 203	1-226-235-00	5 k-B,	adjustable; meter
RV301, 401	1-226-740-00	20 k-A,	variable; REC LEVEL
RV501	1-226-560-00	5 k-B,	variable; BIAS
RV1001	1-226-756-00	50 k-B,	adjustable; tape speed
RV1003, RV1004	1-226-234-00	2 k-B,	adjustable; gain

MISCELLANEOUS

CNJ101 } CNJ201 } CNJ102 } CNJ202 }	1-507-531-00	Jack, phono; 4-p, LINE IN/LINE OUT
CNJ301	1-507-553-00	Jack, HEADPHONES
CNJ302	1-507-648-00	Jack, MIC
CNJ901	1-561-293-00	Socket, 4-p; REMOTE
CP501	1-464-132-00	Unit, bias osc
HE	8-825-604-30	Head, erase; EF206-36B
HRP	8-825-728-00	Combination Head, record/ playback; RPS202-3602A
L101, 201	1-407-240-00	Variable Inductor, 22 mH
L102, 202	1-408-259-00	Microinductor, 15 mH
L301, 401	1-408-253-00	Microinductor, 4.7 mH
L302, 402	1-408-250-00	Microinductor, 2.7 mH
L303, 403, L304, 404	1-408-249-00	Microinductor, 2.2 mH
L501, 502	1-407-177-XX	Microinductor, 470 μH
L801	1-408-096-00	Microinductor, 470 μH
LPF101, LPF201	1-231-388-00	Filter, low-pass
M1	X-3564-044-0	Motor Ass'y, capstan
M2	X-3564-015-0	Motor Ass'y, reel
PL1	1-518-351-00	Lamp, meter
PL2	1-518-340-71	Lamp, cassette
PM1	1-454-222-11	Solenoid, brake
PM2	1-454-222-21	Solenoid, head
S1	1-553-421-00	Switch, lever-slide; MONITOR

<u>Ref. No.</u>	<u>Part No.</u>	<u>Description</u>
S2	1-553-307-00	Switch, rotary; LINE OUT/ PHONES
S3	1-553-420-00	Switch, rotary-slide; TAPE
S4	1-553-306-00	Switch, rotary-slide; DOLBY NR
S6	1-552-520-00	Switch, slide; timer
S7	1-552-876-00	Switch, pushbutton; PEAK HOLD RESET
S8	1-553-072-00	Switch, pushbutton; MEMORY

S801	⚠ 1-553-318-00	Switch, pushbutton; POWER (AEP, UK, E model)
	⚠ 1-553-352-00	Switch, pushbutton; POWER (US model)
	⚠ 1-553-418-00	Switch, pushbutton; POWER (Canadian model)

S802-808	1-552-919-00	Switch Ass'y, function
S809	1-548-537-00	Tape Counter, with switch
S812, 813	1-552-268-00	Switch, slide; accidental erasure prevention, cassette

T901	⚠ 1-446-350-00	Transformer, power (US, Canadian model)
	⚠ 1-446-518-00	Transformer, power (E model)
	⚠ 1-446-834-00	Transformer, power (AEP, UK model)
	⚠ 1-526-576-21	Voltage Selector (E model)
	⚠ 1-534-817-XX	Cord, power (AEP model)
	⚠ 1-534-986-XX	Cord, power (US, Canadian model)
	⚠ 1-551-473-31	Cord, power; parallel blade plug (E model)
	⚠ 1-551-530-00	Cord, power; euro-plug (E model)
	⚠ 1-551-884-00	Cord, power (UK model)

COMPLETE CIRCUIT BOARDS

- ♣ A-2010-168-A Record/playback
- ♣ A-2019-120-A System Control

PRINTED CIRCUIT BOARDS

- ♣ 1-602-631-00 Meter
- ♣ 1-603-112-00 Memory Switch
- ♣ 1-603-113-00 Timer Switch
- ♣ 1-603-114-00 Reset Switch
- ♣ 1-603-115-00 Shut-off

<u>Part No.</u>	<u>Description</u>
♣ 1-603-116-00	Lamp
♣ 1-603-118-00	Mic Amp/REC LEVEL control
♣ 1-603-119-00	Tape Switch
♣ 1-603-120-00	Servo Amp

ACCESSORIES & PACKING MATERIALS

<u>Part No.</u>	<u>Description</u>
X-3701-105-0	Tip Ass'y, head cleaning
1-551-734-11	Cord, connecting; RK-74A
3-429-126-00	Bag, plastic
3-561-142-00	Cushion, upper-front
3-561-143-00	Cushion, upper-back
3-561-144-00	Cushion, lower-right
3-561-145-00	Cushion, lower-left
	(Canadian model)
3-566-148-00	Cushion, upper-front
3-566-149-00	Cushion, upper-back
3-566-150-00	Cushion, lower-right
3-566-151-00	Cushion, lower-left
	(US, AEP, UK, E model)
3-567-250-00	Carton (RM) (E model)
3-574-130-00	Carton (set) (US, AEP, UK, E model)
3-574-131-00	Carton (set) (Canadian model)
3-701-630-00	Bag, plastic
3-783-247-11	Manual, instruction (AEP, UK, E model)
3-783-247-21	Manual, instruction (US, Canadian model)
3-793-481-11	Leaflet
3-793-828-11	Card, cassette caution
3-794-889-31	Manual, instruction; French (Canadian model)
4-818-924-00	Bag, plastic (US, AEP, UK, E model)

ELECTROLYTIC CAPACITORS

CAP. (μF)	RATING → Use the high voltage rated one.					
	6.3 VOLT. PART No.	10 VOLT. PART No.	16 VOLT. PART No.	25 VOLT. PART No.	35 VOLT. PART No.	50 VOLT. PART No.
0.47						1-121-726-00
1.0						1-121-391-00
2.2						1-121-450-00
3.3	→		→	1-121-392-00	→	1-121-393-00
4.7	→		→	1-121-395-00	→	1-121-396-00
10	→		1-121-651-00	1-121-398-00	→	1-121-738-00
22	→		1-121-479-00	1-121-480-00	1-121-662-00	1-121-152-00
33	→		1-121-403-00	1-121-404-00	1-121-652-00	1-121-405-00
47	→	1-121-352-00	1-121-409-00	1-121-410-00	1-121-653-00	1-121-411-00
100	→	1-121-414-00	1-121-415-00	1-121-416-00	1-121-357-00	1-121-417-00
220	1-121-419-00	1-121-420-00	1-121-421-00	1-121-422-00	1-121-261-00	1-121-423-00
330	1-121-751-00	1-121-805-00	1-121-521-00	1-121-654-00	1-121-655-00	1-121-656-00
470	1-121-424-00	1-121-425-00	1-121-426-00	1-121-733-00	1-121-361-00	1-121-810-00
1000		1-121-736-00	1-121-245-00	1-121-657-00	1-121-388-00	1-123-061-00
2200	1-121-658-00	1-121-659-00	1-121-660-00	1-123-067-00	1-121-984-00	
3300	1-121-661-00	1-123-075-00	1-123-071-00			

CAP. (μF)	100 VOLT. PART No.	160 VOLT. PART No.	250 VOLT. PART No.	350 VOLT. PART No.
0.47				
1.0	1-123-249-00	1-123-252-00	1-123-003-00	1-121-168-00
2.2	1-123-250-00	1-123-026-00		1-123-028-00
3.3	1-121-995-00		1-123-004-00	1-123-006-00
4.7	1-123-255-00	1-121-246-00	1-121-759-00	1-123-007-00
10	1-121-126-00	1-121-999-00	1-123-254-00	1-123-008-00
22	1-121-996-00	1-123-253-00	1-123-005-00	1-123-022-00
33	1-121-997-00	1-121-757-00		
47	1-123-251-00	1-121-919-00		
100	1-123-084-00			

CERAMIC CAPACITORS

RATING							
CAP. (pF)	50 VOLT. PART No.	CAP. (pF)	50 VOLT. PART No.	CAP. (pF)	50 VOLT. PART No.	CAP. (μF)	50 VOLT. PART No.
0.5	1-101-837-00	22	1-102-959-00	150	1-101-361-00	0.001	1-102-074-00
0.75	1-101-586-00	24	1-102-960-00	160	1-101-367-00	0.0012	1-102-118-00
1.0	1-102-934-00	27	1-102-961-00	180	1-102-976-00	0.0015	1-102-119-00
1.5	1-101-576-00	30	1-102-962-00	200	1-102-977-00	0.0018	1-102-120-00
2.0	1-102-935-00	33	1-102-963-00	220	1-102-978-00	0.0022	1-102-121-00
3	1-102-936-00	36	1-102-964-00	240	1-102-979-00	0.0027	1-102-122-00
4	1-102-937-00	39	1-102-965-00	270	1-102-980-00	0.0033	1-102-123-00
5	1-102-942-00	43	1-102-966-00	300	1-102-981-00	0.0039	1-102-124-00
6	1-102-943-00	47	1-101-880-00	330	1-102-820-00	0.0047	1-102-125-00
7	1-102-944-00	51	1-101-882-00	360	1-102-821-00	0.0056	1-102-126-00
8	1-102-945-00	56	1-101-884-00	390	1-102-822-00	0.0068	1-102-127-00
9	1-102-946-00	62	1-101-886-00	430	1-102-823-00	0.0082	1-102-128-00
10	1-102-947-00	68	1-101-888-00	470	1-102-824-00	0.01	1-102-129-00
11	1-102-948-00	75	1-101-890-00	510	1-101-059-00	0.022	1-101-005-00
12	1-102-949-00	82	1-102-971-00	560	1-102-115-00	0.047	1-101-006-00
13	1-102-950-00	91	1-102-972-00	680	1-102-116-00		
15	1-102-951-00	100	1-102-973-00	820	1-102-117-00		
16	1-102-952-00	110	1-102-815-00				
18	1-102-953-00	120	1-102-816-00				
20	1-102-958-00	130	1-101-081-00				

0.001μF = 1,000pF

CERAMIC (SEMICONDUCTOR) CAPACITORS

RATING → Use the high voltage rated one.					
CAP. (μF)	25 VOLT. PART No.	50 VOLT. PART No.	CAP. (μF)	25 VOLT. PART No.	50 VOLT. PART No.
0.001	→	1-161-039-00	0.018	1-161-016-00	1-161-054-00
0.0012	→	1-161-040-00	0.022	1-161-017-00	1-161-055-00
0.0015		1-161-041-00	0.027	1-161-018-00	1-161-056-00
0.0018		1-161-042-00	0.033	1-161-019-00	1-161-057-00
0.0022		1-161-043-00	0.039	1-161-010-00	1-161-058-00
0.0027	→	1-161-044-00	0.047	1-161-021-00	1-161-059-00
0.0033	→	1-161-045-00	0.056	→	1-161-060-00
0.0039	→	1-161-046-00	0.068	→	1-161-061-00
0.0047	→	1-161-047-00	0.082	1-161-024-00	1-161-062-00
0.0056	→	1-161-048-00	0.1	1-161-025-00	1-161-063-00
0.0068	→	1-161-049-00			
0.0082	1-161-013-00	1-161-050-00			
0.01	1-161-013-00	1-161-051-00			
0.012	→	1-161-052-00			
0.015	1-161-015-00	1-161-053-00			

MYLAR CAPACITORS

CAP. (μF)	RATING																	
	50 VOLT.			100 VOLT.			200 VOLT.			50 VOLT.			100 VOLT.			200 VOLT.		
	PART No.	PART No.	PART No.	CAP. (μF)	PART No.	PART No.	PART No.	CAP. (μF)	PART No.	PART No.	PART No.	CAP. (μF)	PART No.	PART No.	PART No.	CAP. (μF)	PART No.	PART No.
0.001	1-108-227-00	1-108-365-00	1-108-409-00	0.01	1-108-239-00	1-108-377-00	1-108-421-00	0.1	1-108-251-00	1-108-389-00	1-108-433-00							
0.0012	1-108-351-00	1-108-366-00	1-108-410-00	0.012	1-108-357-00	1-108-378-00	1-108-422-00	0.12	1-108-363-00	1-108-390-00	1-108-434-00							
0.0015	1-108-228-00	1-108-367-00	1-108-411-00	0.015	1-108-240-00	1-108-379-00	1-108-423-00	0.15	1-108-252-00	1-108-391-00	1-108-435-00							
0.0018	1-108-352-00	1-108-368-00	1-108-412-00	0.018	1-108-358-00	1-108-380-00	1-108-424-00	0.18	1-108-364-00	1-108-392-00	1-108-436-00							
0.0022	1-108-230-00	1-108-369-00	1-108-413-00	0.022	1-108-242-00	1-108-381-00	1-108-425-00	0.22	1-108-254-00	1-108-393-00	1-108-437-00							
0.0027	1-108-353-00	1-108-370-00	1-108-414-00	0.027	1-108-359-00	1-108-382-00	1-108-426-00	0.27	1-108-854-00									
0.0033	1-108-232-00	1-108-371-00	1-108-415-00	0.033	1-108-244-00	1-108-383-00	1-108-427-00	0.33	1-108-855-00									
0.0039	1-108-354-00	1-108-372-00	1-108-416-00	0.039	1-108-360-00	1-108-384-00	1-108-428-00	0.39	1-108-856-00									
0.0047	1-108-234-00	1-108-373-00	1-108-417-00	0.047	1-108-246-00	1-108-385-00	1-108-429-00	0.47	1-108-857-00									
0.0056	1-108-355-00	1-108-374-00	1-108-418-00	0.056	1-108-361-00	1-108-386-00	1-108-430-00											
0.0068	1-108-237-00	1-108-375-00	1-108-419-00	0.068	1-108-249-00	1-108-387-00	1-108-431-00											
0.0082	1-108-356-00	1-108-376-00	1-108-420-00	0.082	1-108-362-00	1-108-388-00	1-108-432-00											

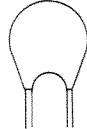

TANTALUM CAPACITORS

CAP. (μF)	RATING → Use the high voltage rated one.						
	3.15 VOLT.	6.3 VOLT.	10 VOLT.	16 VOLT.	20 VOLT.	25 VOLT.	35 VOLT.
	PART No.	PART No.	PART No.	PART No.	PART No.	PART No.	PART No.
0.01					→	→	1-131-396-00
0.015					→	→	1-131-397-00
0.022					→	→	1-131-398-00
0.033					→	→	1-131-399-00
0.047					→	→	1-131-400-00
0.068					→	→	1-131-401-00
0.1					→	→	1-131-402-00
0.15					→	→	1-131-403-00
0.22					→	→	1-131-404-00
0.33					→	1-131-409-00	1-131-405-00
0.47					1-131-412-00	→	1-131-406-00
0.68				1-131-415-00	→	1-131-410-00	1-131-407-00
1.0			1-131-418-00		1-131-413-00	→	1-131-408-00
1.5		1-131-421-00		1-131-416-00	→	1-131-411-00	1-131-348-00
2.2	1-131-424-00		1-131-419-00		1-131-414-00	1-131-355-00	1-131-349-00
3.3		1-131-422-00		1-131-417-00	1-131-362-00	1-131-356-00	1-131-350-00
4.7	1-131-425-00		1-131-420-00	1-131-369-00	1-131-363-00	1-131-357-00	1-131-351-00
6.8		1-131-423-00	1-131-376-00	1-131-370-00	1-131-364-00	1-131-358-00	1-131-352-00
10	1-131-426-00	1-131-383-00	1-131-377-00	1-131-371-00	1-131-365-00	1-131-359-00	1-131-353-00
15	1-131-390-00	1-131-384-00	1-131-378-00	1-131-372-00	1-131-366-00	1-131-360-00	
22	1-131-391-00	1-131-385-00	1-131-379-00	1-131-373-00	1-131-367-00		
33	1-131-392-00	1-131-386-00	1-131-380-00	1-131-374-00			
47	1-131-393-00	1-131-387-00	1-131-381-00				
68	1-131-394-00	1-131-388-00					
100	1-131-395-00						



TANTALUM CAPACITORS

CAP. (μF)	RATING						
	3 VOLT.	6.3 VOLT.	10 VOLT.	16 VOLT.	20 VOLT.	35 VOLT.	
	PART No.	PART No.	PART No.	PART No.	PART No.	PART No.	
0.033						1-131-273-00	
0.047						1-131-274-00	
0.068						1-131-275-00	
0.1						1-131-276-00	
0.15						1-131-277-00	
0.22						1-131-278-00	
0.33						1-131-279-00	
0.47			1-131-169-00			1-131-280-00	
0.68				1-131-258-00	1-131-265-00	1-131-281-00	
1.0			1-131-254-00		1-131-266-00	1-131-282-00	
1.5		1-131-250-00			1-131-267-00	1-131-283-00	
2.2				1-131-259-00	1-131-268-00	1-131-284-00	
3.3			1-131-255-00		1-131-269-00		
4.7		1-131-251-00	1-131-171-00		1-131-270-00		
6.8				1-131-260-00	1-131-271-00		
10			1-131-256-00		1-131-272-00		
15		1-131-252-00		1-131-261-00			
22			1-131-257-00				
33	1-131-176-00	1-131-253-00	1-131-173-00				
47	1-131-288-00	1-131-174-00					
100	1-131-177-00						

1/4 WATT CARBON RESISTORS

1.0	1-246-401-00	10	1-246-425-00	100	1-246-449-00	1.0k	1-246-473-00	10k	1-246-497-00	100k	1-246-521-00	1.0M	1-246-545-00
1.1	1-246-402-00	11	1-246-426-00	110	1-246-450-00	1.1k	1-246-474-00	11k	1-246-498-00	110k	1-246-522-00	1.1M	1-210-814-00
1.2	1-246-403-00	12	1-246-427-00	120	1-246-451-00	1.2k	1-246-475-00	12k	1-246-499-00	120k	1-246-523-00	1.2M	1-210-815-00
1.3	1-246-404-00	13	1-246-428-00	130	1-246-452-00	1.3k	1-246-476-00	13k	1-246-500-00	130k	1-246-524-00	1.3M	1-210-816-00
1.5	1-246-405-00	15	1-246-429-00	150	1-246-453-00	1.5k	1-246-477-00	15k	1-246-501-00	150k	1-246-525-00	1.5M	1-210-817-00
1.6	1-246-406-00	16	1-246-430-00	160	1-246-454-00	1.6k	1-246-478-00	16k	1-246-502-00	160k	1-246-526-00	1.6M	1-210-818-00
1.8	1-246-407-00	18	1-246-431-00	180	1-246-455-00	1.8k	1-246-479-00	18k	1-246-503-00	180k	1-246-527-00	1.8M	1-210-819-00
2.0	1-246-408-00	20	1-246-432-00	200	1-246-456-00	2.0k	1-246-480-00	20k	1-246-504-00	200k	1-246-528-00	2.0M	1-210-820-00
2.2	1-246-409-00	22	1-246-433-00	220	1-246-457-00	2.2k	1-246-481-00	22k	1-246-505-00	220k	1-246-529-00	2.2M	1-210-821-00
2.4	1-246-410-00	24	1-246-434-00	240	1-246-458-00	2.4k	1-246-482-00	24k	1-246-506-00	240k	1-246-530-00	2.4M	1-244-754-00
2.7	1-246-411-00	27	1-246-435-00	270	1-246-459-00	2.7k	1-246-483-00	27k	1-246-507-00	270k	1-246-531-00	2.7M	1-244-755-00
3.0	1-246-412-00	30	1-246-436-00	300	1-246-460-00	3.0k	1-246-484-00	30k	1-246-508-00	300k	1-246-532-00	3.0M	1-244-756-00
3.3	1-246-413-00	33	1-246-437-00	330	1-246-461-00	3.3k	1-246-485-00	33k	1-246-509-00	330k	1-246-533-00	3.3M	1-244-757-00
3.6	1-246-414-00	36	1-246-438-00	360	1-246-462-00	3.6k	1-246-486-00	36k	1-246-510-00	360k	1-246-534-00	3.6M	1-244-758-00
3.9	1-246-415-00	39	1-246-439-00	390	1-246-463-00	3.9k	1-246-487-00	39k	1-246-511-00	390k	1-246-535-00	3.9M	1-244-759-00
4.3	1-246-416-00	43	1-246-440-00	430	1-246-464-00	4.3k	1-246-488-00	43k	1-246-512-00	430k	1-246-536-00	4.3M	1-244-760-00
4.7	1-246-417-00	47	1-246-441-00	470	1-246-465-00	4.7k	1-246-489-00	47k	1-246-513-00	470k	1-246-537-00	4.7M	1-244-761-00
5.1	1-246-418-00	51	1-246-442-00	510	1-246-466-00	5.1k	1-246-490-00	51k	1-246-514-00	510k	1-246-538-00	5.1M	1-244-762-00
5.6	1-246-419-00	56	1-246-443-00	560	1-246-467-00	5.6k	1-246-491-00	56k	1-246-515-00	560k	1-246-539-00		
6.2	1-246-420-00	62	1-246-444-00	620	1-246-468-00	6.2k	1-246-492-00	62k	1-246-516-00	620k	1-246-540-00		
6.8	1-246-421-00	68	1-246-445-00	680	1-246-469-00	6.8k	1-246-493-00	68k	1-246-517-00	680k	1-246-541-00		
7.5	1-246-422-00	75	1-246-446-00	750	1-246-470-00	7.5k	1-246-494-00	75k	1-246-518-00	750k	1-246-542-00		
8.2	1-246-423-00	82	1-246-447-00	820	1-246-471-00	8.2k	1-246-495-00	82k	1-246-519-00	820k	1-246-543-00		
9.1	1-246-424-00	91	1-246-448-00	910	1-246-472-00	9.1k	1-246-496-00	91k	1-246-520-00	910k	1-246-544-00		

HARDWARE NOMENCLATURE

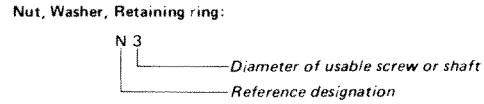
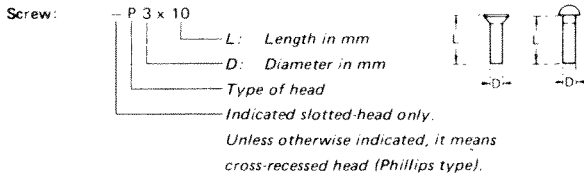

Reference Designation	Shape	Description	Remarks
SCREWS			
P		pan-head screw	binding-head (B) screw for replacement
PWH		pan-head screw with washer face	binding-head (B) screw and flat washer for replacement
PS PSP		pan-head screw with spring washer	binding-head (B) screw and spring washer for replacement
PSW PSPW		pan-head screw with spring and flat washers	binding-head (B) screw and spring and flat washers for replacement
R		round-head screw	binding-head (B) screw for replacement
K		flat-countersunk-head screw	
RK		oval-countersunk-head screw	
B		binding-head screw	
T		truss-head screw	binding-head (B) screw for replacement
F		flat-fillister-head screw	
RF		fillister-head screw	
BV		brazer-head screw	

Reference Designation	Shape	Description	Remarks
SELF-TAPPING SCREWS			
TA		self-tapping screw	ex: TA, P 3 x 10
PTP		pan-head self-tapping screw	binding-head self-tapping (TA, B) screw for replacement
PTPWH		pan-head self-tapping screw with washer face	binding-head self-tapping (TA, B) screw and flat washer for replacement
PTTWH		pan-head thread-rolling screw with washer face	binding-head (B) screw and flat washer for replacement
SET SCREWS			
SC		set screw	
SC		hexagon-socket set screw	ex: SC 2.6 x 4, hexagon socket
NUT			
N		nut	
WASHERS			
W		flat washer	
SW		spring washer	
LW		internal-tooth lock washer	ex: LW3, internal
LW		external-tooth lock washer	ex: LW3, external
RETAINING RINGS			
E		retaining ring	
G		grip-type retaining ring	

